

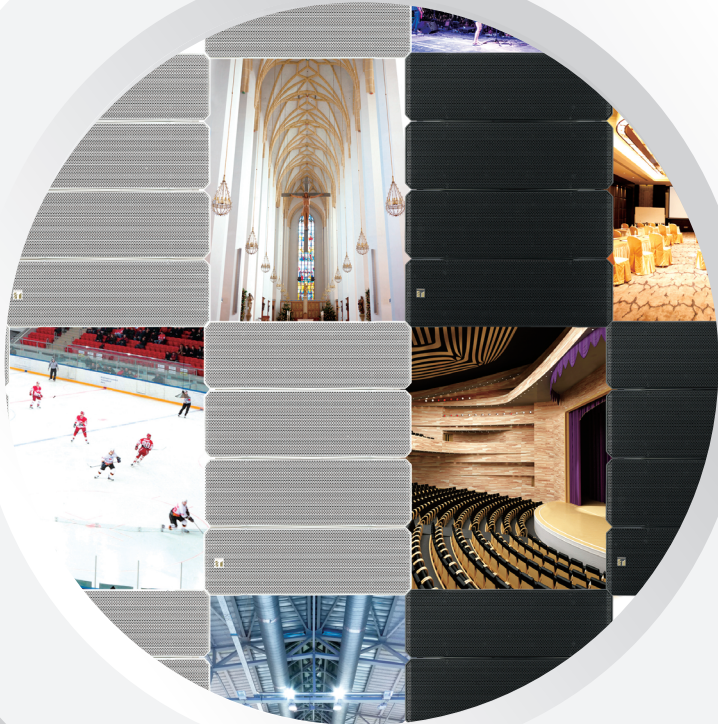

Line Array Speakers

Z-HX Series-AS



from a whisper to a scream, full area coverage and wider bandwidth sound

What is Line Array Speaker?

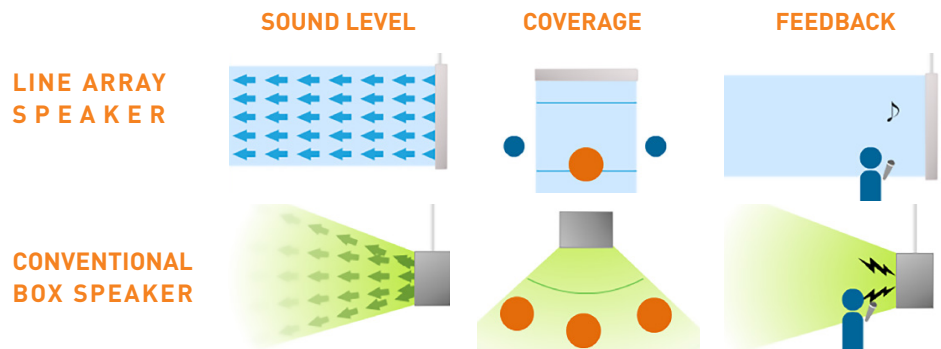

Features of TOA Line Array Speakers

Powerful & compact variable dispersion line array with flexible installation options.

Thanks to its award-winning enclosure design, employing four modules per unit, the Z-HX Series allows precise adjustment of sound dispersion angles.

- ▮ Versatile mounting options
- ▮ Adjustable Dispersion
- ▮ Advantage of multi-unit configuration
- ▮ Best solution for acoustically challenging spaces:
Sport Venues, House of Worship, Concert Halls, Boardroom



Maximum four speaker units can be stacked.

*Make sure that 3 or 4-stacked Z-HX units are suspended from 3 or more hanging points.

*TOA's optional HY-VM7B or HY-VM7W Speaker Mounting Brackets are required for three- or four- speaker installation. For details, refer to the installation manual of HY-VM7B or HY-VM7W brackets.

TOA Line Array Speakers

Z-7HX-AS Series Features

- Variable dispersion line array with SYNC-Drive wave guide technology
- Power handling: 750W Continuous Program@8 ohms
- One module is composed of 2 x 5.5" LF speakers and waveguide loaded 1" HF compression driver
- Adjustable dispersion angle 0, 15, 30, 45 and 60° (60° requires optional HY-60D)
- 0° mode facilitates the most effective line array set-up.
- Maximum four speaker units can be stacked
- Built-in isophasic wave-front control horn ensures precise HF control and superior reproduction of HF sounds
- Splash-proof version (IPX4) available



Z-5B-HX2 Series Features

- More compact and affordable choice
- Power handling: 400W Continuous Program@8 ohms
- One module is composed of 1 x 4.72" cone-type LF driver and 3 x 1" balanced dome tweeters
- Adjustable dispersion angle 15, 30, 45 and 60°
- Maximum four speaker units can be stacked
- Splash-proof version (IPX4) available





Z-7B-HX-2M Features

- More compact and affordable choice
- Power handling: 375W Continuous Program@16 ohms
- One module is composed of 2 x 5.5" LF speakers and waveguide loaded 1" HF compression driver
- 0° mode facilitates the most effective line array set-up.



Z-7HX-AS Series

Specifications	Z-7B-HX-AS	Z-7W-HX-AS	Z-7BW-HX-AS	 Z-7WW-HX-AS	
Enclosure	Bass-reflex type		Sealed type		
Power Handling Capacity	Continuous pink noise: 250W (IEC60268-5: 350W) / Continuous program: 750W				
Rated Impedance	8Ω				
Sensitivity (1W, 1m)	100dB				
Frequency Response	75Hz – 20kHz		105Hz – 20kHz		
Crossover Frequency	1.7kHz				
Directivity Angle	Horizontal: 100°, Vertical: Depending on directivity angle mode				
Speaker Component	Low frequency: 13 cm cone-type x 8 High frequency: Wave front control horn with compression driver x 4				
Input Terminal	Speakon NL4MP x 2 and M4 screw terminal, distance between barriers: 9mm (0.35")		M4 screw terminal, distance between barriers: 9mm (0.35") IPX4 (Install with every speaker module tilted downward from the horizontal.)		
Water Protection	-		-		
Finish	Enclosure: Polypropylene, black or white (Z-7B/W-HX-AS) Punched net: Surface-treated steel plate, black or white (Z-7B/W-HX-AS), paint / Hanging bracket: Steel plate, t3.0, black or white (Z-7B/W-HX-AS), paint		Enclosure: Polypropylene, black or white (Z-7B/WWP-HX-AS), Punched net: Surface-treated steel plate, black & white (Z-7B/WWP-HX-AS), rust proof coating		
Dimensions (W x H x D)	497 x 664 x 274 mm				
Weight	30 kg				

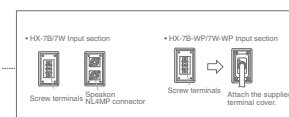
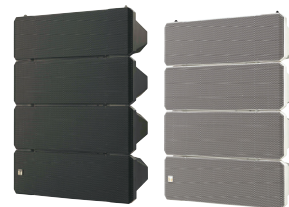

Specifications	Z-FB152B-AS	Z-FB152W-AS
Power Handling Capacity	Continuous pink noise: 300W / Continuous program: 900W	
Impedance	8Ω	
Sensitivity (1W, 1m)	91 dB	
Frequency Response	40Hz – 400Hz (-10dB) with DP-SP3	
Speaker Component	38 cm cone-type	
Input Terminal	Speakon NL4MP x 2 and M4 screw terminal	
Finish	Enclosure: MDF, black or white, urethane paint Punched net: Surface-treated steel plate, black & white, paint	
Dimensions (W x H x D)	505 x 530 x 655 mm	
Weight	35 kg	



Z-7HX-AS Series

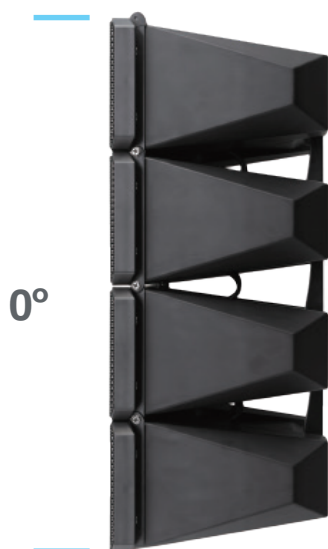

0°

Controlled dispersion

Five Stages

Adjustable dispersion angle

0°, 15°, 30°, 45°, 60°



45°

Wider coverage

Mounting Options

Two speakers connected
HY-CN7W / HY-CN7W-WP /
HY-CN7B / HY-CN7B-WP

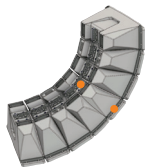

On the wall
HY-WM7W / HY-WM7B



Dispersion angle 60 degrees
HY-60DW / HY-60DW-WP /
HY-60DB / HY-60DB-WP

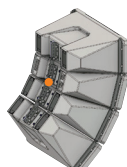

On building structures
HY-TM7W-WP / HY-TM7B-WP

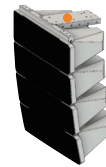

Hanging vertically with subwoofer
HY-PF7W / HY-PF7B



On undereave walls
HY-MS7W-WP / HY-MS7B-WP



On the ceiling
HY-VM7W / HY-VM7B

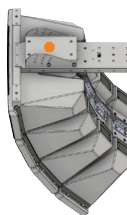

On the stand
HY-ST7



Accessories

		Article number
	Speaker Connection Bracket, white	HY-CN7W* HY-CN7W-WP
	Speaker Connection Bracket, black	HY-CN7B* HY-CN7B-WP
	Angle Adjustment Bar, white Allows the dispersion angle 60 degrees.	HY-60DW* HY-60DW-WP
	Angle Adjustment Bar, black Allows the dispersion angle 60 degrees.	HY-60DB* HY-60DB-WP
	Rigging Frame, white	HY-PF7W*
	Rigging Frame, black	HY-PF7B*
	Rigging Bracket, white	HY-VM7W*
	Rigging Bracket, black	HY-VM7B*

		Article number
	Wall Mounting Bracket, white	HY-WM7W*
	Wall Mounting Bracket, black	HY-WM7B*
	Rigging Bracket, white, outdoor use	HY-TM7W-WP
	Rigging Bracket, black, outdoor use	HY-TM7B-WP
	Wall Mounting Bracket, white, outdoor use	HY-MS7W-WP
	Wall Mounting Bracket, black, outdoor use	HY-MS7B-WP
	Matching Transformer Adapter	HY-MT7
	Speaker Stand Adapter	HY-ST7*

*Indoor use only

Z-5B-HX2 Series

Specifications	Z-5B-HX2	Z-5W-HX2	Z-5BW-HX2	Z-5WW-HX2
Enclosure	Bass-reflex type		Sealed type	
Power Handling Capacity	Continuous pink noise: 200W / Continuous program: 400W			
Rated Impedance	8 Ω			
Sensitivity (1W, 1m)	96 dB (60° mode), 97 dB (45° mode), 98 dB (30° mode), 99 dB (15° mode)			
Frequency Response	70 Hz – 20 kHz (-10 dB) (60° mode) 75 Hz – 20 kHz (-10 dB) (45° mode) 80 Hz – 20 kHz (-10 dB) (30° mode) 85 Hz – 20 kHz (-10 dB) (15° mode)		95 Hz – 20 kHz (-10 dB) (60° mode) 100 Hz – 20 kHz (-10 dB) (45° mode) 105 Hz – 20 kHz (-10 dB) (30° mode) 110 Hz – 20 kHz (-10 dB) (15° mode)	
Crossover Frequency	4kHz			
Directivity Angle	Horizontal: 100° (over 2kHz), Vertical: 60° (over 800Hz), 45° (over 1.2kHz), 30° (over 1.6kHz), 15° (over 3.2kHz) variable			
Speaker Component	Low frequency: 12 cm cone-type x 4, High frequency: Balanced dome-type x 12			
Input Terminal	Speakon NL4MP x 2 and M4 screw terminal		-	
Speaker Cord	-		2-core cabtyre cord with diameter of 6mm	
Water Protection	-		IP X4 (Install with every speaker module downward)	
Finish	Enclosure: Polypropylene, black or white / Punched net: Surface-treated steel plate, black or white			
Dimensions (W x H x D)	408 x 546 x 342mm			
Weight	16kg			

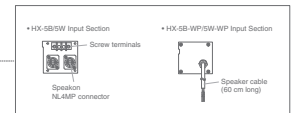

Specifications	Z-120BFB	Z-120WFB
Rated Input	Continuous pink noise: 200W / Continuous program: 600W	
Impedance	8 Ω	
Sensitivity (1W, 1m)	90 dB at installation in free sound field, 96 dB at installation in 1/2 free sound field	
Frequency Response	40Hz – 1.2kHz (-10 dB)	
Speaker Component	30cm cone-type speaker	
Input Terminal	Speakon NL4MP x 2 and M4 screw terminals	
Finish	Enclosure plywood, metal front grille black white	
Dimensions (W x H x D)	408 x 408 x 450mm	
Weight	15kg	



Z-5B-HX2 Series

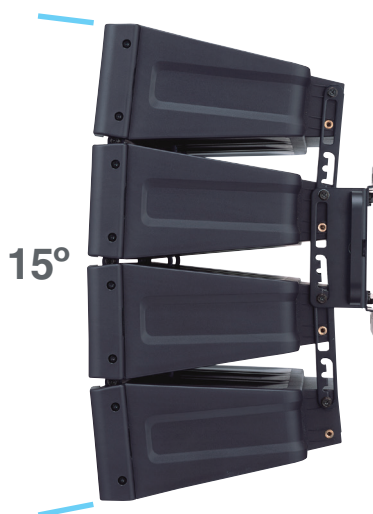

15°

Four Stages

Adjustable dispersion angle
15°, 30°, 45°, 60°

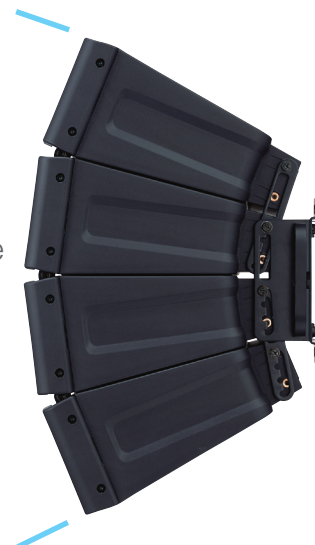

60°

Mounting Options

Hanging horizontally

HY-PF1B / HY-PF1W / HY-PF1WP



Hanging vertically with subwoofer



On the ceiling vertically

HY-CW1B / HY-CW1W / HY-CW1WP

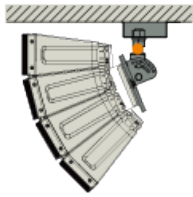

On the ceiling horizontally

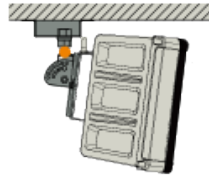

Two speakers connected

HY-CN1B / HY-CN1W / HY-CN1BWP / HY-CN1WWP



On the wall horizontally

HY-WM1B / HY-WM1W / HY-WM1WP

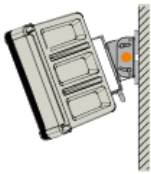

On the wall vertically



On the wall vertically

HY-WM2B / HY-WM2W / HY-WM2WP

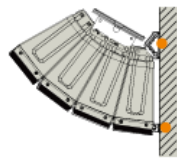

On the wall horizontally

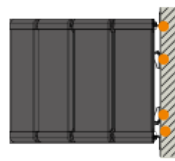

On the ceiling vertically

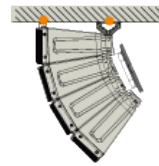



















On the stand

HY-ST1



Accessories

		Article number			Article number
	Rigging Frame, black	HY-PF1B*		Wall Mounting Bracket, black	HY-WM2B*
	Rigging Frame, white	HY-PF1W*		Wall Mounting Bracket, white	HY-WM2W*
	Rigging Frame, outdoor use	HY-PF1WP		Wall Mounting Bracket, outdoor use	HY-WM2WP
	Ceiling Mounting Bracket, black	HY-CW1B*		Extension Bracket, black	HY-CN1B*
	Ceiling Mounting Bracket, white	HY-CW1W*		Extension Bracket, white	HY-CN1W*
	Ceiling Mounting Bracket, outdoor use	HY-CW1WP		Extension Bracket, outdoor use, black	HY-CN1BWP
	Wall Mounting Bracket, black	HY-WM1B*		Extension Bracket, outdoor use, white	HY-CN1WWP
	Wall Mounting Bracket, white	HY-WM1W*		Speaker Stand Adapter	HY-ST1*
	Wall Mounting Bracket, outdoor use	HY-WM1WP		Matching Transformer	MT-200

*Indoor use only

Z-7B-HX-2M

Specifications	Z-7B-HX-2M
Enclosure	Bass-reflex type
Power Handling Capacity	Continuous pink noise: 125W (IEC60268-5: 350W) / Continuous program: 375W
Rated Impedance	16Ω
Sensitivity (1W, 1m)	93dB
Frequency Response	75Hz – 20kHz
Crossover Frequency	1.7kHz
Directivity Angle	Vertical: Depending on directivity angle mode
Speaker Component	Low frequency: 13 cm cone-type x 4 High frequency: Wave front control horn with compression driver x 2
Input Terminal	Speakon NL4MP x 2
Finish	Enclosure: Polypropylene, black Punched net: Surface-treated steel plate, black, paint
Dimensions (W x H x D)	497 x 345 x 274 mm
Weight	16kg

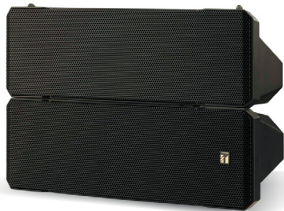

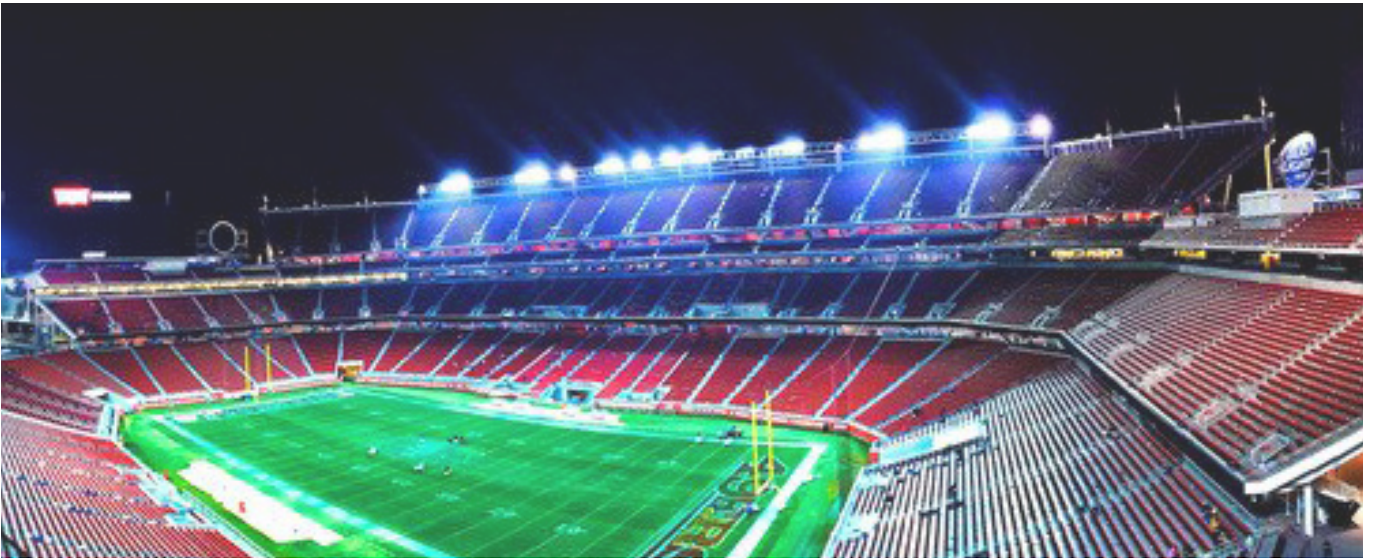

Line array speaker is an ideal solution for acoustically challenging venues which have reflective ceiling or highly reverberant space.



Scan for more info

 **TOA**
Smiles for the Public

Specifications are subject to change without notice.