

■ SPECIFICATIONS

Product Composition	Wireless transmitter ...1, Receiver ...1, Lavalier microphone ...1
Frequency Range	633 - 671MHz, UHF
Channel Selectable	4 Channels
Tunable Frequencies	25kHz Steps
Pilot tone	32.768kHz
Total Harmonic Distortion	<1% @ 1kHz
Function	IR sync, Channel scan, Battery life information
Accessory	AC adapter ... 1
	Screw driver ... 1
	Lavalier Microphone ... 1

Wireless transmitter

Microphone Element	Back electret condenser; Omni-directional
RF Carrier Power	Typical 10mW
Audio Frequency Response	50 - 15000 Hz
Audio input Level	-6dBV (maximum), mic gain 0dB
Modulation System	PLL synthesizer
Battery	1 AA size alkaline battery, 1.5 V
Battery Life	Approx. 10 hours
Indicator	Battery status LED, 7 segments LED
Finish	Resin, coating
Dimensions	62(W) x 100(H) x 25(D) mm (with clip)
Weight	approx. 85 g (with battery)

Wireless receiver

Diversity Reception	AC mains (supplied AC-DC adapter must be used)
Sensitivity	10uV at 45dBA S/N
Squelch(SQ)	Tone SQ, Carrier SQ, Noise SQ
Audio Frequency Response	50 - 15000Hz
Audio Output Level (Maximum)	S4.04-RX Balanced (XLR socket) : -20dBu Un-balanced (1/4" jack socket) : 10dBu
Power Supply	11-18 VDC 300mA
Dimensions	215(W) x 39(H) x 102(D) mm (excluding antenna and BNC)
Weight	480g
Option	Mounting bracket kit: MB-S4RX (MB-S4RX-5)

■ APPEARANCE

Wireless Transmitter

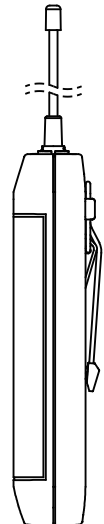
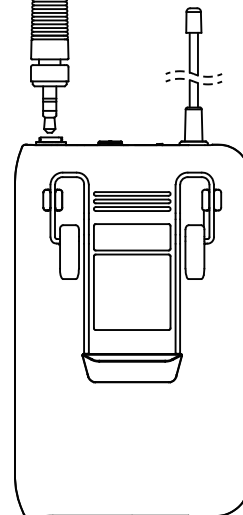
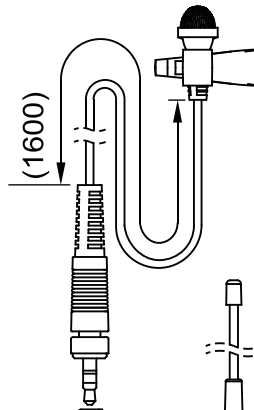
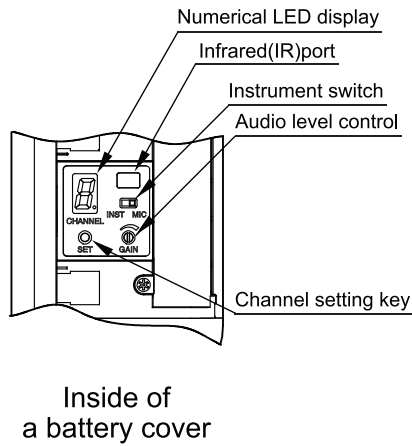
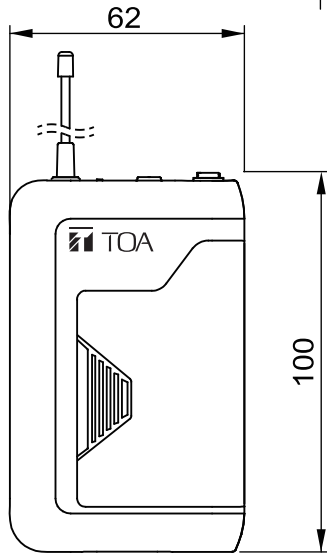
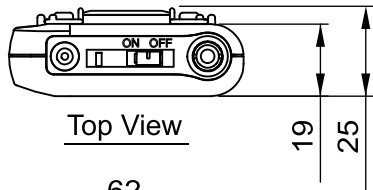

Wireless Receiver

Rear View

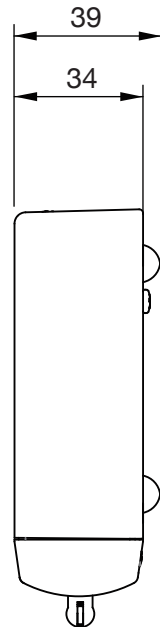
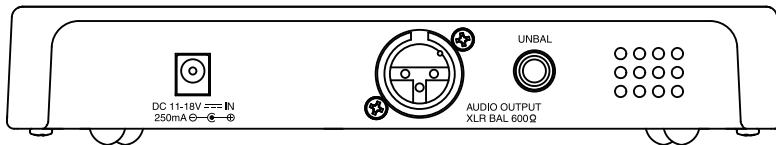

Top View

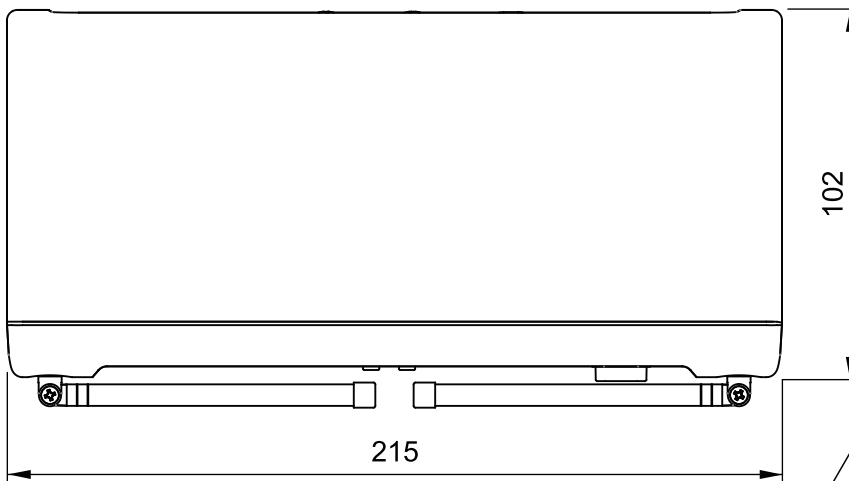

Front View

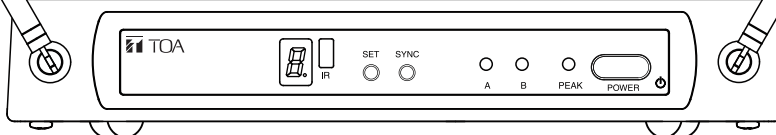

Side View

UNIT : mm SCALE : 1 / 2