



Digital communications, coupled with TOA audio quality provides an outstanding conference system that can be adapted to fit any size room.

DIGITAL CONFERENCE SYSTEM

TS-D1000 Series
TS-D1100 Series



Professional and Passionate

Conference system amplifies
the power and influence of your speech

Minimal Footprint

With its pyramid-shaped contour, the conference unit blends beautifully with any decor.

Natural appearance,
as if protruding from the desk.

Solid Construction

The newly designed case provides an exceptional atmosphere for conferences.



Excellent Coherence and Intelligibility

A full spread surface that creates a direct path between the presenter and the loudspeaker.

The Speaker is right in front of you

The shape of the unit equipment required for the conference hall is straightforwardly shaped, such as the back shape that suppresses the blockage of view, the real voice as if the speaker is facing you, and the air in the hard parliament. Unit design that relieves the impression of "talking through equipment" and fosters a more direct feeling of dialogue.

Your message reaches to the audience perfectly

Carefully designed audio processing and hardware for enhanced audio performance

High Quality Audio

Carefully designed audio processing and hardware enhance audio performances to get your messages through.

No Interference

Advanced feedback suppressor (FBS) minimizes acoustic feedback.

No Missing Words

Auto gain control (AGC) function provides uniform sound volume by adjusting the gain based on how loud or soft the speaker's voice is.

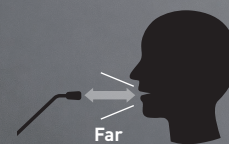
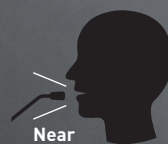

Designed for meeting facilitators



Intelligible conversations in conference or board rooms for up to 246 participants.



Long microphone option to make a room for your laptop or documents.

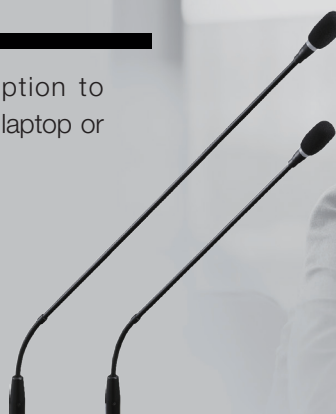



Facilitator-supporting function

Chairman's Unit Priority Function

- Chairman Unit has priority override control.
- Smooth operation of the conference is assured by a Chairman Unit's priority function.

Setting for Number of Open Microphones

- The Chairman can select the number of delegates who speak simultaneously to guide the discussion.
- Up to eight Delegate Units for simultaneous operation is allowed and if one or two Chairman Units are included, they may speak simultaneously.

Participant-supporting feature

Voice Activation Mode

Start talking instead of pressing the button.

Microphone can be activated in response to a person's voice.

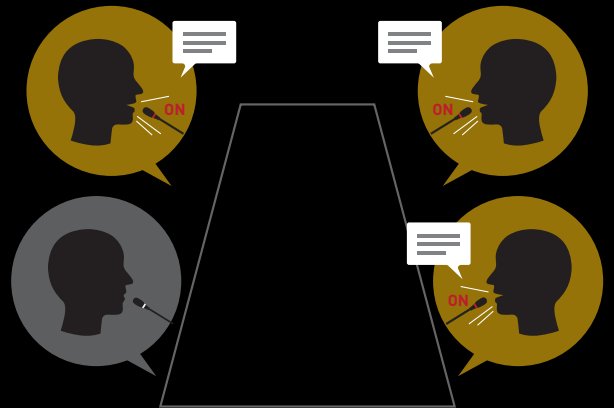

Administrator-supporting feature

Easy Maintenance

A Shielded CAT5e STP cable carries signals between conference units or between the Master Control Unit and a conference unit.



The long microphone is long enough to allow you to make a room for your PC.

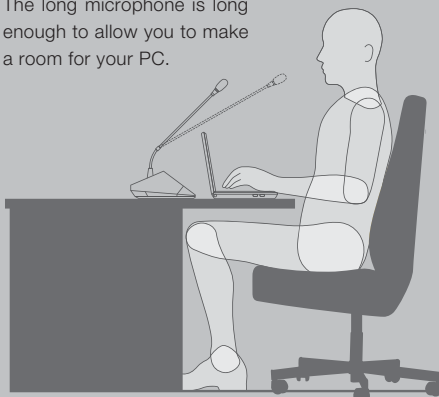

Master Control Unit | Key Functions



Built-in volume control for monitor speaker.

Operation Mode

STANDARD : Optimized for a meeting where the chairman assigns who will talk the next.

OVERRIDE : Optimized for a meeting where the participants talk in order.

VOICE ACTIVATION : Optimized for an open discussion (all conversations are sent to record output).

CHAIRMAN ONLY : Optimized for a presentation style meeting. The presenter will reach every participant clearly thanks to a built-in speaker on each unit.

Energy Saving Mode

Conference system automatically switched off after 2 hours of inactivity.

TS-D1000-MU
TS-D1100-MU



Built-in Audio Recording

Meetings can be recorded in mp3 format on USB drive or internal memory*.

*Internal recording up to 18 hours at 128 kbps.



Hybrid Conference

Connection to a PC enables audio input and output during Web meetings and conferences.

*TS-D1100-MU only

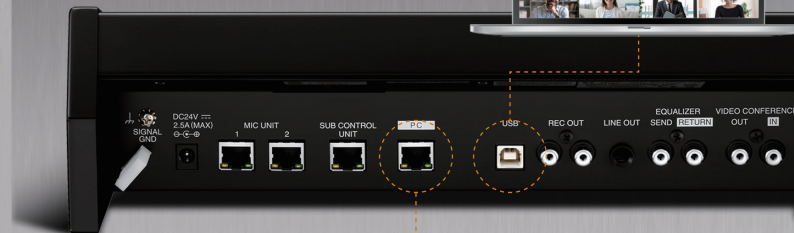

Web Browser Application

Built-in web browser application is available. Advanced settings can be made from a PC or tablet.

System Configuration / Components

Max 246 Conference units

+

Remote WEB meetings

*TS-D1100-MU only

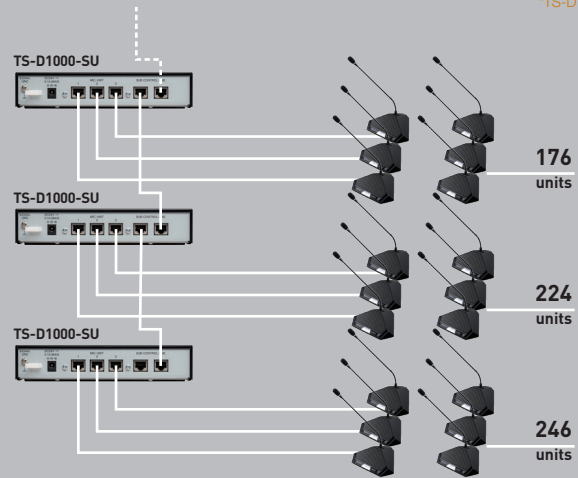
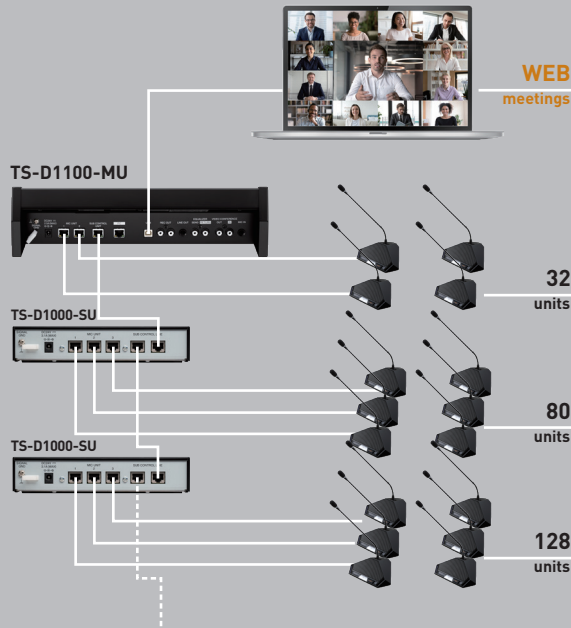

TS-D1100-MU Master Control Unit

- USB Audio In/out (USB 2.0 type-B port)
- Supports up to 32 conference units
- Mic In, Aux In, Line Out, Rec Out, Headphone monitor out, EQ in/out
- Function setting : Number of open microphones, Auto mic-off function, Microphone priority selector
- Rack-mountable with optional MB-TS920 bracket



TS-D1000-MU Master Control Unit

- Supports up to 32 conference units
- Mic In, Aux In, Line Out, Rec Out, Headphone monitor out, EQ in/out
- Function setting : Number of open microphones, Auto mic-off function, Microphone priority selector
- Rack-mountable with optional MB-TS920 bracket

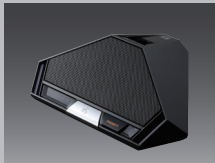

TS-D1000-CU Chairman Unit

- Chairman unit for basic discussion
- Priority button
- 0.4W monitor speaker
- 2 headphone jacks with individual volume control
- PoE powered

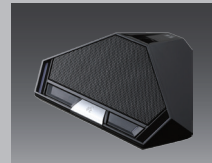

TS-D1000-DU Delegate Unit

- Delegate unit for basic discussion
- 0.4W monitor speaker
- 2 headphone jacks with individual volume control
- PoE powered



TS-D1000-M1 Microphone

- Gooseneck microphone
- Unidirectional electret condenser microphone
- LED shows microphone status
- XLR-3-32 connector
- Sensitivity: -37 dB (1 kHz, 0 dB = 1 V / PA)
- Frequency response: 100 Hz - 13 kHz
- Length: 518 mm (1.7 ft)



TS-D1000-M2 Microphone [Long]

- Gooseneck microphone
- Unidirectional electret condenser microphone
- LED shows microphone status
- XLR-3-32 connector
- Sensitivity: -37 dB (1 kHz, 0 dB = 1 V / PA)
- Frequency response: 100 Hz - 13 kHz
- Length: 668 mm (2.19 ft)



TS-D1000-SU Sub Control Unit

- Controls up to 48 Conference Units
- Up to 5 Sub Control Units connectable to the Master Control Unit with the supplied LAN cable.
- Only 22 conference units can be connected to the 5th Sub Control Unit



TS-D1000-EX Extension Unit

- Provides up to 150m distance over Shielded CAT5e



MB-TS920 Rack Mounting Bracket

- For use with TS-D1000-MU

