



N-SP80MS1 SIP Multimedia Station

User Manual

Content

1 Welcome.....	6
2 Product Overview	8
2.1 Instruction	8
2.2 Technical Specification	9
2.3 Equipment Appearance And Interface Description	10
2.3.1 Interface Description.....	11
2.3.2 Keypad Description	11
2.4 Indicators.....	12
3 Installation	13
3.1 Equipment Packaging	13
3.2 Connecting Video Phone	13
3.3 Installation Considerations	14
4 Getting Started	15
4.1 Basic Operation	15
4.1.1 Main Screen Instruction.....	15
4.1.2 Status And Notifications Instruction	16
4.1.3 Using The Touchscreen.....	17
4.1.4 Startup And Shutdown.....	17
4.1.5 View / Turn Off Notifications	18
4.2 Connecting To Network And Wi-Fi	18
4.2.1 Configuring Static IP	19
4.2.2 Configuring DHCP	20
4.2.3 Configuring PPPOE	21
4.2.4 Configuring Wi-Fi.....	22
4.3 SIP Account Configuration	26
4.3.1 Add Account	27
4.3.2 SIP Account ON/OFF	29
4.3.3 Modify/Remove SIP Account	29
4.4 Sound	30
4.4.1 Silent Mode	31
4.4.2 Volumes.....	32
4.4.3 Ringtone	32
4.4.4 System Sound.....	33
4.5 Audio Settings	33
4.6 Video Settings	34

4.7 Call Settings.....	35
4.7.1 Do Not Disturb	36
4.7.2 Call Waiting	36
4.7.3 Always forwarding & Forwarding Number	37
4.7.4 Call forwarding busy & Forwarding Number	37
4.7.5 No Answer Forwarding & Forwarding Number	37
4.7.6 Time out.....	38
4.7.7 Playtone	38
4.7.8 Intercom.....	38
4.8 Dial Plan	38
4.9 Auto Provision.....	39
4.10 Personalize	40
4.10.1 Log Level.....	40
4.10.2 Hook Mode	40
4.11 Reboot Manager	40
4.11.1 Reboot time	40
4.11.2 Status of time	41
4.11.3 Status of active.....	41
4.11.4 Reboot settings	41
4.12 Date & Time	41
4.13 Personalization Settings	44
4.13.1 Wallpaper	44
4.13.2 Widgets	45
4.13.3 Shortcuts	47
4.13.4 Modify Extended Bar	48
4.13.5 Ringtone	48
4.14 Backup & Reset	49

5 Function..... 50

5.1 Call Function.....	50
5.1.1 Make A Call	50
5.1.2 Dial Out From Contact.....	52
5.1.3 Receive A Call	53
5.1.4 Call Options	55
5.1.5 Call Records	56
5.2 Contacts	59
5.2.1 Local Phone Book.....	59
5.2.2 Broadsoft Phone Book	62
5.2.3 Remote Phone Book	62
5.2.4 LDAP	62
5.2.5 Group	63
5.3 BLF	64
5.4 Intercom.....	66
5.5 Call Return.....	67

5.6 BLFList	67
5.7 Pickup & Group Pickup.....	68
5.8 ACD.....	69
5.9 Hot Desking	70
5.10 Conference	71
5.10.1 Create 3-way conference	71
5.11 Transfer	72
5.11.1 Blind Transfer	72
5.11.2 Attended Transfer	73
5.12 Keypad Input	74
5.13 Webpage Browser	74
5.13.1 Open The Webpage.....	74
5.14 Camera	75
5.14.1 Photograph Mode	75
5.15 Gallery	77
5.15.1 View Photo & Picture & Video	77
5.16 Bluetooth	78
5.16.1 Turning Bluetooth On /Off	79
5.16.2 Changing Bluetooth Device Name	79
5.16.3 Paring N-SP80MS1 With A Bluetooth Device	79
5.16.4 Un-pairing A Bluetooth Device.....	80
5.17 USB.....	80
5.18 Calendar	81
5.18.1 Add An Account.....	81
5.18.2 View Calendar	82
5.18.3 New Activities	82
5.18.4 Edit Activities.....	83
5.18.5 Delete Activities	83
5.19 Clock.....	84
5.19.1 Alarm.....	84
5.19.2 Countdown Timer	86
5.19.3 Stopwatch	87
5.20 Email.....	87
5.20.1 Add A New Email Account.....	87
5.21 Music.....	88
5.22 Explorer	89
5.23 Video Player	90
5.24 Others.....	91
5.24.1 Apk Installer	91
5.24.2 Ping Tool.....	92

6 Software Upgrade **95**

6.1 Immediate Update	95
6.1.1 Select Other Upgrade Package.....	96

6.1.2 Local Update.....	96
6.1.3 Remote Update	97
6.2 Auto Update Period.....	99
6.3 Upgrade on the web.....	100
6.4 Check Update After System Power On.....	100

7 System Maintenance 102

7.1 System State Inspection	102
7.2 IP Query.....	102
7.3 SIP Account Registration Query	103
7.4 Backup & Reset	104
7.5 Failure Process	104

8 Web Interface 106

8.1 Web login	106
8.2 Status->Basic	107
8.3 Account->Basic	108
8.4 Account->Advanced	110
8.5 Network->Basic	115
8.6 Network ->Advanced.....	116
8.7 Phone->Time/Lang.....	117
8.8 Phone->Preference	118
8.9 Phone ->Call Feature.....	119
8.10 Phone->Audio	123
8.11 Phone->Video	124
8.12 Phone->Ext Key	126
8.13 Phone->Dial Plan (Replace Rule).....	127
8.14 Phone->Dial Plan (Dial Now).....	128
8.15 Phone->Action URL	129
8.16 Phone->Multicast.....	131
8.17 PhoneBook->Local Book.....	133
8.18 PhoneBook->Remote Book	134
8.19 PhoneBook->Call Log	135
8.20 PhoneBook->LDAP	136
8.21 PhoneBook->Broadsoft	137
8.22 Upgrade->Basic	139
8.23 Upgrade->Advanced.....	140
8.24 Security->Basic	142
8.25 Security->Advanced	143

1 Welcome

Thank you for purchasing TOA N-SP80MS1 SIP Multimedia Station. The N-SP80MS1 is an innovative smart desk phone loaded with tremendous value for business communications as well as unprecedented power for advanced custom business applications development and personalization. Featuring Android 4.2 system, a 7 inch capacitive touch screen TFT LCD, a 2M CMOS sensor camera, Bluetooth, integrated PoE and Wireless, N-SP80MS1 provides excellent user experiences such as high quality video phone, smooth internet surfing, various 3rd party applications and daily information. Built with advanced security protection for privacy, this SIP Multimedia Station also features broad interoperability with most 3rd party SIP based devices, IPPBX and major IMS platforms. The N-SP80MS1 represents the future multimedia terminal in modern Internet age.

This user manual is designed to help you understand how to configure and manage the N-SP80MS1 SIP Multimedia Station. Besides demonstrating how to install this unit with ease, this manual will explain how to fully utilize the phone's voice calling features as well as explore all the built-in feature-rich applications.

FCC Caution:

Any Changes or modifications not expressly approved by the party responsible for compliance could void the user's authority to operate the equipment. This device complies with part 15 of the FCC Rules. Operation is subject to the following two conditions: (1) This device may not cause harmful interference, and (2) this device must accept any interference received, including interference that may cause undesired operation.

FCC Radiation Exposure Statement:

This equipment complies with FCC radiation exposure limits set forth for an uncontrolled environment. This equipment should be installed and operated with minimum distance 20cm between the radiator& your body.

This transmitter must not be co-located or operating in conjunction with any other antenna or transmitter.

Note: This equipment has been tested and found to comply with the limits for a Class B digital device, pursuant to part 15 of the FCC Rules. These limits are designed to provide reasonable protection against harmful interference in a residential installation. This equipment generates uses and can radiate radio frequency energy and, if not installed and used in accordance with the instructions, may cause harmful interference to radio communications. However, there is no guarantee that interference will not occur in a particular installation. If this equipment does cause harmful interference to radio or television reception, which can be determined by turning the equipment off and on, the user is encouraged to try to correct the interference by one or more of the following measures:

- ✓ Reorient or relocate the receiving antenna.
 - ✓ Increase the separation between the equipment and receiver.
 - ✓ Connect the equipment into an outlet on a circuit different from that to which the receiver is connected.
-

2 Product Overview

2.1 Instruction

N-SP80MS1 is an Android-based multimedia terminal with a 7 inch touch screen and a 2M CMOS sensor camera. It supports H.264/H.263 codec with adaptive bandwidth adjustment. The 7 inch touch screen offers excellent user experiences such as high quality videophone, smooth internet surfing, various Android Apps and daily information.

N-SP80MS1 provides 2 Ethernet ports, 1USB, 1HDMI, and one 3.5mm headset/audio port.



2.2 Technical Specification

Model	N-SP80MS1
Graphic Display	<ul style="list-style-type: none"> ● 7 inch capacitive touch screen TFT LCD, 1024x600 pixels, 16:9 wide screen aspect ratio
Camera	<ul style="list-style-type: none"> ● 2 mega pixels CMOS camera, free rotation
Network Protocol	<ul style="list-style-type: none"> ● SIP RFC3261,TCP/UDP/IP,PPPOE,RTP/RTCP
Operation System	<ul style="list-style-type: none"> ● Android 4.2
Voice Codec	<ul style="list-style-type: none"> ● G.711A/U, G.723, G.729a/b, G.722, iLBC, ● AMR-NB, AMR-WB, OPUS
Video Codec	<ul style="list-style-type: none"> ● H.263, H.264
DTMF Modes	<ul style="list-style-type: none"> ● Inband, RFC2833, SIP INFO
Audio Features	<ul style="list-style-type: none"> ● VAD, CNG, Echo Canceller G.165/G.168
Video Features	<ul style="list-style-type: none"> ● QCIF, CIF, 4CIF, VGA,720P ● Video bitrate: 64kbps~2Mbps ● PIP ● Full Screen ● local video ON/OFF control ● Image Codec: JPEG,GIF,PNG,BMP
Others	<ul style="list-style-type: none"> ● Download content from the specified server ● Information receiving, storing, and rendering capabilities ● Web browser ● Contacts and Call records management ● Support playing local or online video
Network Interface	<ul style="list-style-type: none"> ● Dual switched 10/100/1000Mbps port, supporting IEEE802.11af and IEEE802.az Energy Efficient Ethernet; optional PoE
Wi-Fi	<ul style="list-style-type: none"> ● IEEE802.11 b/g/n
Expansion Interface	<ul style="list-style-type: none"> ● USB 2.0, 3.5mm headset jack, HDMI
IP assignment	<ul style="list-style-type: none"> ● Static IP, DHCP, PPPoE
Management	<ul style="list-style-type: none"> ● LCD Menu Configuration,TR069, WebUI
Dimension	<ul style="list-style-type: none"> ● 240×192×106mm

2.3 Equipment Appearance And Interface Description

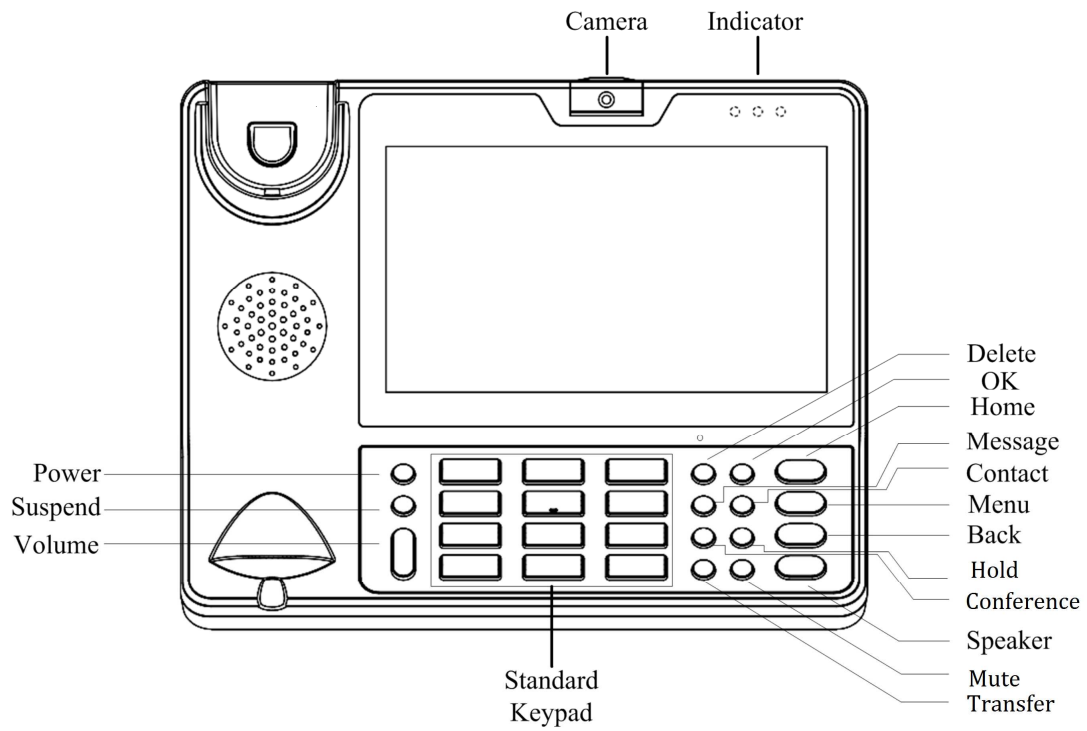

Figure 1-1 N-SP80MS1 Front View

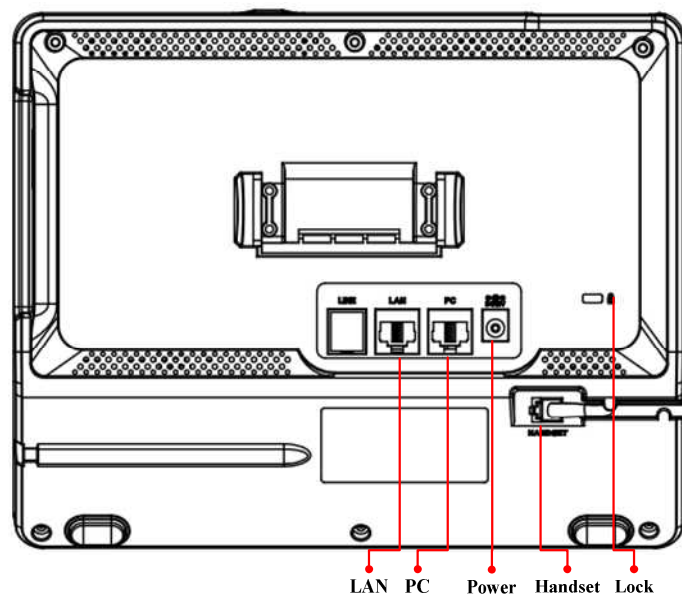

Figure 1-2 N-SP80MS1 Rear View

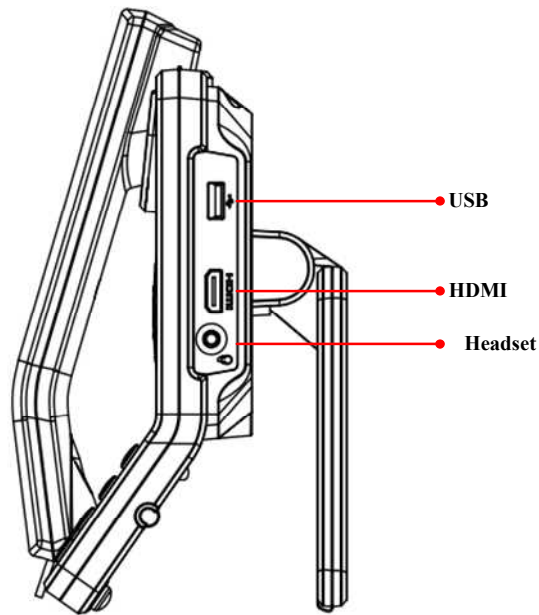

Figure 1-3 N-SP80MS1 Profile View





2.3.1 Interface Description

Interface	Description
Camera	Adjustable camera shooting angle, rotate down the camera to "off" angle.
USB interface	External USB storage device
Headset	Connect to 3.5mm stereo headphone, headset device
HDMI	Use HDMI cable to output the video to a TV screen
LAN	Network interface can be connected to a hub, switch or other network access devices. It also supports POE(Power over Ethernet) .
PC	Share the network access from LAN port, and for PC and other equipment connection
Power	Connect to 12V adapter, Power supply
Handset	Connect to handset
Lock	Lock the video phone with a Laptop lock



Note: If Power over Ethernet is being used, do not plug in the AC adapter.

2.3.2 Keypad Description

Interface	Description
Power	Turn on/off the LCD, Reboot, Silent mode
Suspend	Turn on/off the LCD, Reboot, Silent mode

Volume	Press + or – for the phone volume adjustment	
Standard Keypad	Input the number or symbol	
Function Key	Delete	Delete a character before the cursor
	OK	Same function with soft keyboard "Enter" key
	Message	Optional
	Contact	Enter Into the contacts list, you can view the local contact
	Conference	The first party is held in the case, according to a conference key, the first party can be combined to achieve a tripartite meeting
	Hold	To hold a call during the call
	Transfer	To transfer the current call to the third party
	Mute	The other party cannot heard the voice during the call
Home		Return to the main screen, and long press, it will display recently used applications
Menu		To call up the System or program setup menu
Back		Return to the previous menu
Speaker		Speaker

2.4 Indicators

Indicator Name	Icon	Status	Description
Power		ON	System is under working
		OFF	System is not working
Network Connection		ON	Network (LAN Port) is connected
		OFF	Network (LAN Port) is disconnected
Information		Flashing	Contains Miss Calls or Unread Message
		OFF	Normal status

3 Installation

3.1 Equipment Packaging

Name	Quantity
Main Case	1
Handset	1
Phone Cord	1
Power Adapter	1
Ethernet Cable	1
Quick Start Guide	1

3.2 Connecting Video Phone

- Connection diagram

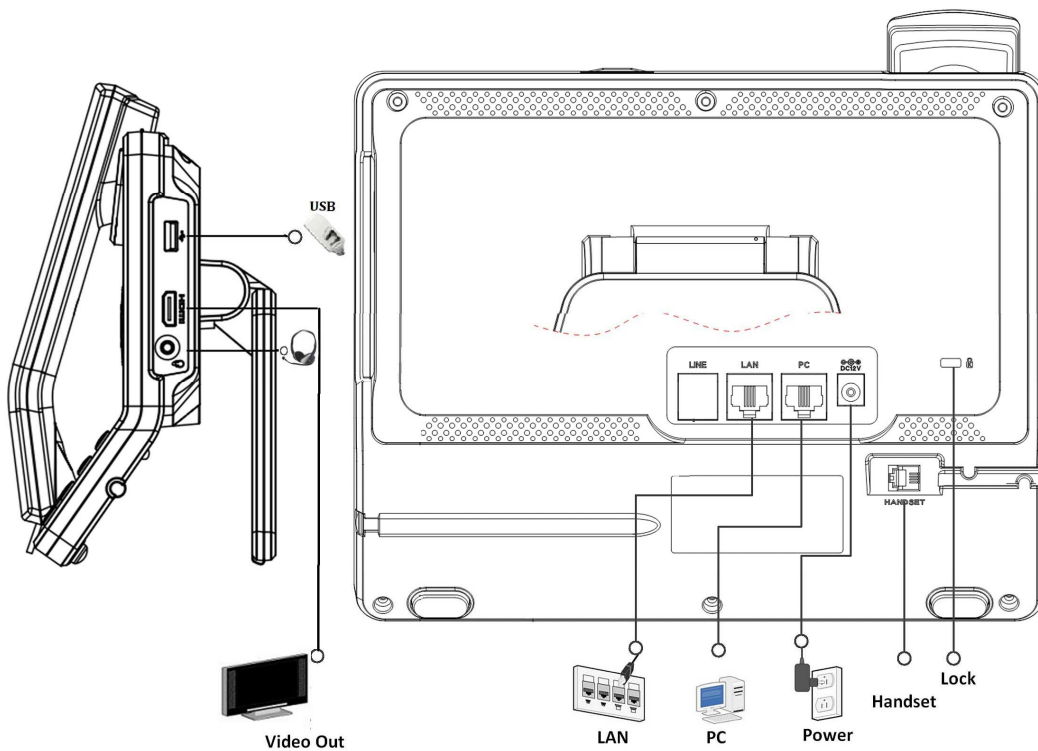

- **Connecting to Network**

Use the matched network cable to connect the LAN Port of the video phone to the Router or Switch. Viewing the top right corner of the screen, if the indicator light  is on, network cable is connected properly.

- **Connecting to PC**

Use the matched network cable to connect the PC Port of the video phone. The PC can access to the internet network via PC Port of the video phone.

3.3 Installation Considerations

This product is a desktop product, and here are some safety recommendations about the installation and the usage:

- Do not use this product near water, such as: bath, washbasin, kitchen sink and other damp places and so on;
- Place the device in a place away from heat;
- Place the device away from traffic areas to prevent collisions;
- Please use the equipment with the matching power adapter or POE;

4 Getting Started

4.1 Basic Operation

4.1.1 Main Screen Instruction

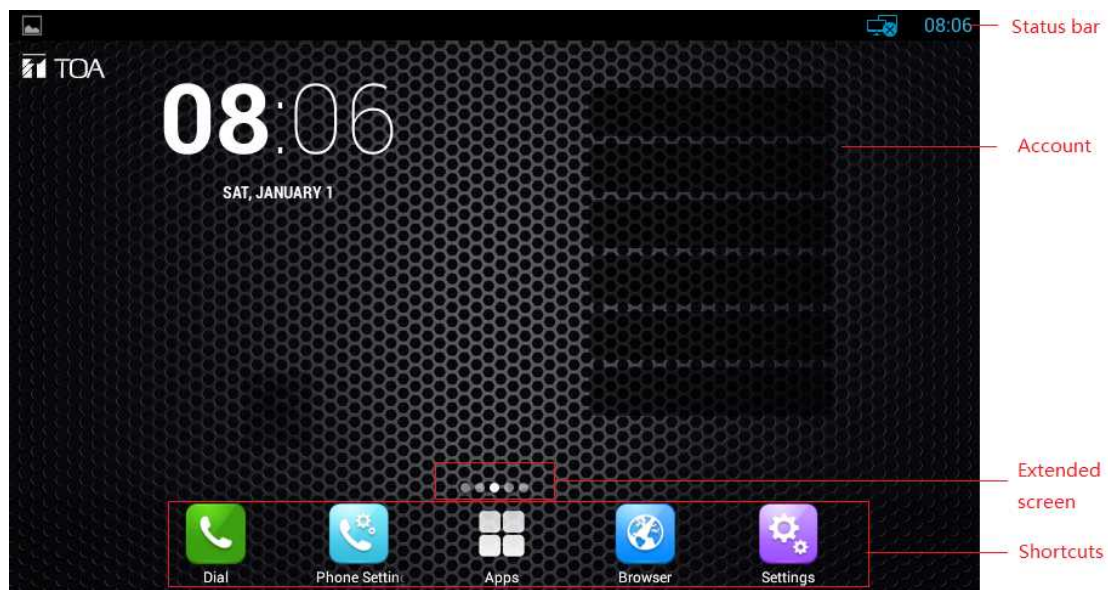







- Status bar, at the top of the screen, displaying the status of system information.
- Accounts, N-SP80MS1 supports 6 lines. Accounts list will show the status of the current account.
- Extended Screen Prompt, Display the location of current screen page; and show how many pages extended.
- Shortcuts, at the bottom of the screen, user can drag a shortcut to this region to achieve the replacement of the shortcut. Supports max four shortcuts.

4.1.2 Status And Notifications Instruction







The status bar in main screen is divided into two zones, notification area and status area, as shown below:



Status Area

Icon	Description
	Network is connected
	Network is not connected
	Mute mode
	Alarm clock is set
	PPPOE is connected
	PPPOE is failed

Notification Area

Icon	Description
	SIP account is registered
	Missed call, number means how many missed calls
	downloading
	uploading
	Receives a new email
	An event is coming

4.1.3 Using The Touchscreen

- **Tap**

To select items on the screen (e.g., setting options, apps); to press onscreen buttons; to type letters and symbols using the onscreen keyboard.

- **Touch and Hold**

Touch the item on the screen and hold it without lifting your finger from the screen till an action occurs.

For example, touch and hold on a picture to bring up operation options.

- **Drag**

Touch and hold an item for a few seconds first. Once the item has a red frame activated, or a move option shows up, keep your finger on the screen and move it until the target position is reached. Then lift your finger up to release.

- **Slide**

Move your finger fast across the screen to slide. To view different idle screens or menu pages, slide left or right; to view the status bar on top of the screen, place your finger on the bar and slide it down. If your finger stays on the screen for too long, the item may be selected and sliding won't occur.

- **Double-click**

Click on the screen twice in quick succession, for example, when user surfs in browser, you can quickly click twice on the page, the page can be enlarged.

- **Pinch**

Place two fingers on the screen, then pinch them together (zoom out) or spread them apart (zoom in). This could be used in a picture.

4.1.4 Startup And Shutdown

- **Startup**

Connect to the power supply, the system automatically starts up.

- **Shutdown**

If you do not use the device, directly remove the power supply, to save electricity.

- **Reboot**

If you need to restart the device, according to the following steps:

- 1) Press and hold the "Power" button until the pop-up "Options" menu.
- 2) Click the "Reboot"

4.1.5 View / Turn Off Notifications

When viewing notifications, simply press and hold the status bar, drag down, as shown below:

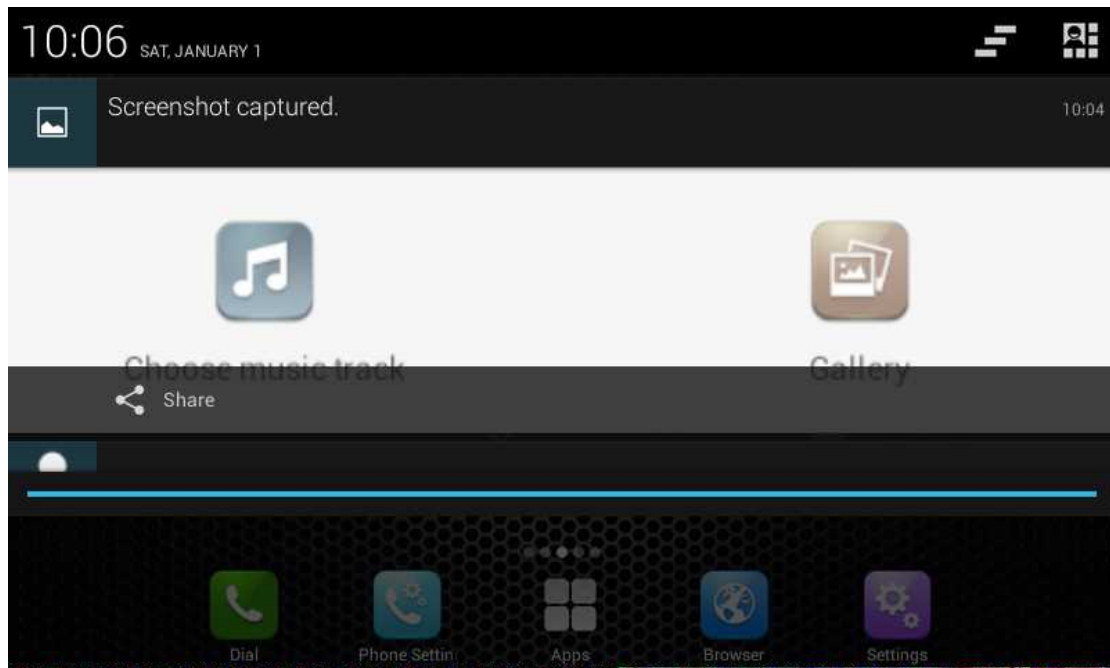

To turn off notifications, simply hold the notice at the bottom of the screen and then drag up or press the "Back" on the hard keyboard. Click on the icon  to clear up the notice





4.2 Connecting To Network And Wi-Fi

N-SP80MS1 supports a variety of network connections (Ethernet, Wireless) and device Network connections includes four modes, Static IP, DHCP, PPPOE, Wi-Fi access. DHCP is the default configuration. Device connections include EHS headset,

USB and Bluetooth device.

4.2.1 Configuring Static IP

You can select one of the following methods to enter the static IP configuration:

- Mode 1: In the main screen, press "Menu" key on the hard keyboard-> System Settings-> Wireless & Networks-> Ethernet-> Using static IP.
- Mode 2: In the main screen, tap -> Settings-> Wireless & Networks-> Ethernet-> Using static IP.
- Mode 3: Drag down the status bar, click shortcut icon  on the status bar ->SETTINGS-> ->Wireless & Networks-> Ethernet->Use static IP.
- Mode 4: In the main screen, tap ->Network Settings->LAN Connecting->Static IP.

Configuration page is shown as below:

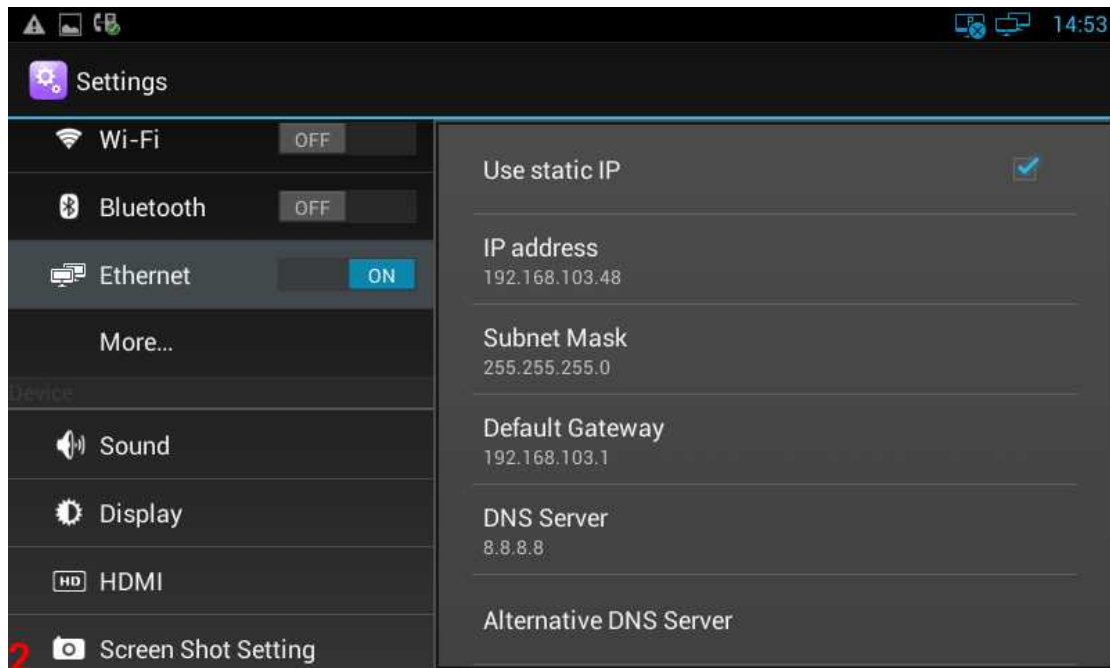





Configuration parameter specification:

Parameter	Specification
IP address	set the IP address of the device
Subnet Mask	set the subnet mask of the device

Default Gateway	set the default gateway
DNS Server	set the DNS address
Alternative DNS Server	set the backup DNS address

4.2.2 Configuring DHCP

You can select one of the following methods to enter the DHCP configuration:

- Mode 1: In the main screen, press "Menu" key on the hard keyboard-> System Settings-> Wireless & Networks-> Ethernet-> uncheck Using static IP.
- Mode 2: In the main screen, tap -> Settings-> Wireless & Networks-> Ethernet -> uncheck Using static IP.
- Mode 3: Drag down the status bar, click shortcut icon  on the status bar ->click SETTINGS icon ->Wireless & Networks-> Ethernet-> uncheck Use static IP.
- Mode 4: In the main screen, tap  ->Network Settings->LAN Connecting->DHCP.

Configuration page is shown as below:

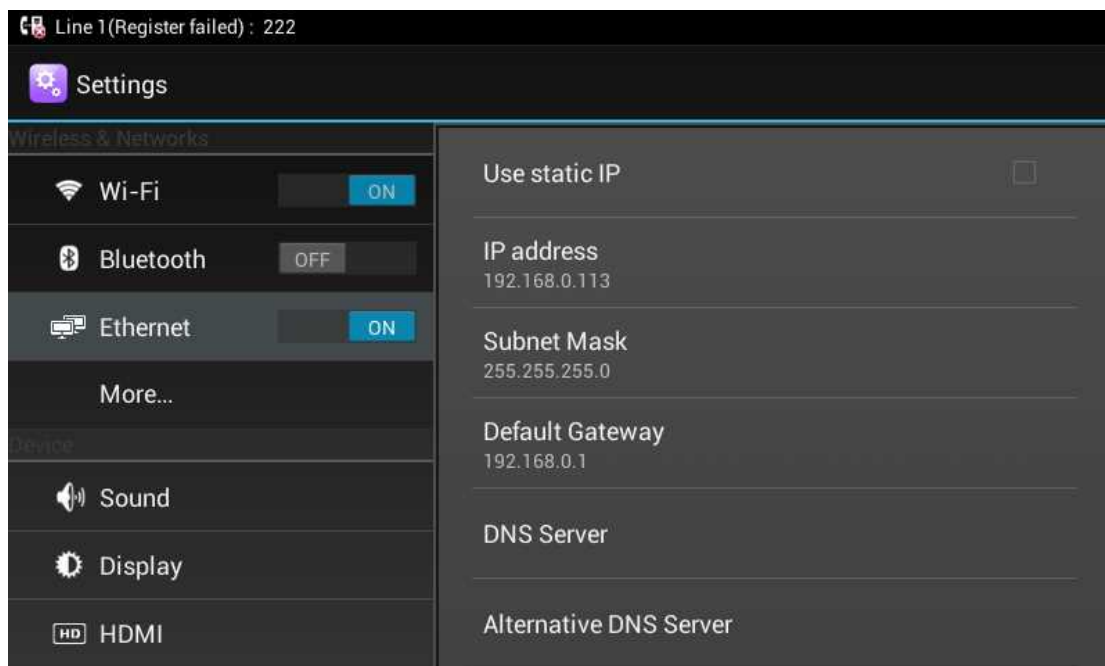





Note:

- 1) If DHCP acquired IP, it will display dynamic IP address information on the location of static IP configuration, cannot be modified, and there is an item of Use static DNS at the bottom the alternative DNS server, when checked, you can modify the primary DNS address and Secondary DNS address.
- 2) If DHCP is failed, the IP address will show as: 0.0.0.0.

4.2.3 Configuring PPPOE

You can select one of the following methods to enter the PPPOE configuration:

- Mode 1: In the main screen, press "Menu" key on the hard keyboard-> System Settings-> Wireless & Networks -> Ethernet ->More ->PPPOE.
- Mode 2: In the main screen, tap -> Settings-> Wireless & Networks-> Ethernet -> More ->PPPOE.
- Mode 3: Drag down the status bar, click shortcut icon  on the status bar ->SETTINGS ->Wireless & Networks-> Ethernet-> More ->PPPOE.
- Mode 4: In the main screen, tap  ->Network Settings->LAN Connecting->PPPOE

Configuration page is shown as below:

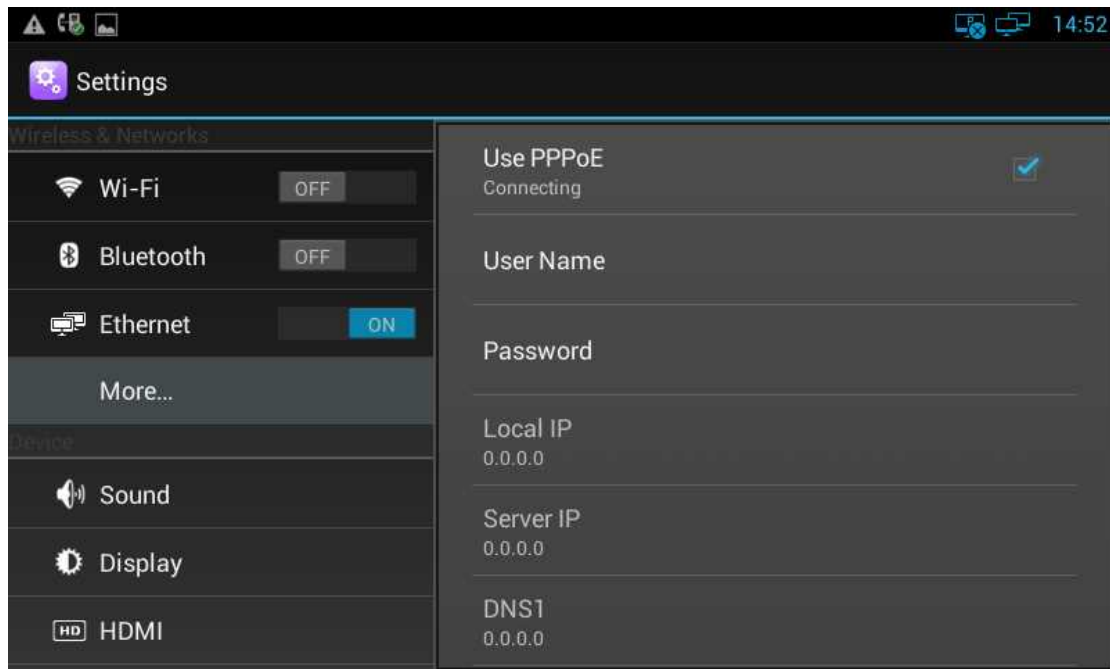

Parameter specification:

Parameter	Specification
Use PPPOE	Check <input checked="" type="checkbox"/> is to enable PPPOE, otherwise, disable.
User Name	PPPOE account, provided by ISP
Password	PPPOE password, provided by ISP

Proceed as follows:



- 1) Check Use PPPOE
- 2) Enter the correct user name and password of PPPOE

Note:

- 1) After dialing, can display the acquired IP address, server IP, the primary DNS, Secondary DNS information, status as connected
- 2) Not Dial, IP address information will be 0.0.0.0
- 3) There is a redial entry under Alternate DNS, click redial, then re-launch a PPPOE dial-up process, re-dial.

4.2.4 Configuring Wi-Fi

You can select one of the following methods to enter the Wi-Fi configuration:

- Mode 1: In the main screen, press "Menu" key on the hard keyboard-> System Settings-> Wireless & Networks-> Ethernet->Wi-Fi.
- Mode 2: In the main screen, tap -> Settings-> Wireless & Networks-> Ethernet->Wi-Fi.
- Mode 3: Drag down the status bar, click shortcut icon  on the status bar



Configuration page is shown as below:

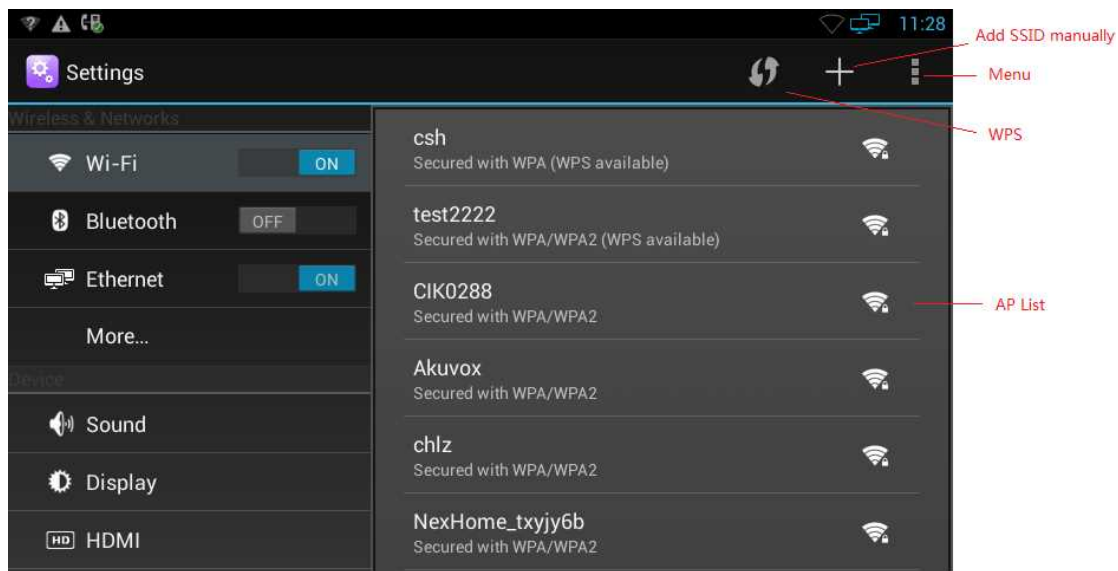

- 1) When the Wi-Fi switch is turned on, the video phone can list and display all Wi-Fi AP searched in the environment;
- 2) When connects to available AP in the environment, if a Wi-Fi AP is without password protection, there is no lock icon on Wi-Fi signal, it will automatically connect when clicked;
- 3) If a Wi-Fi AP is encryption, Wi-Fi signal will be added the lock icon, and when checked, it will pop up a dialog box to enter a password. If the password is incorrect, the connection will not be successful, as shown below:

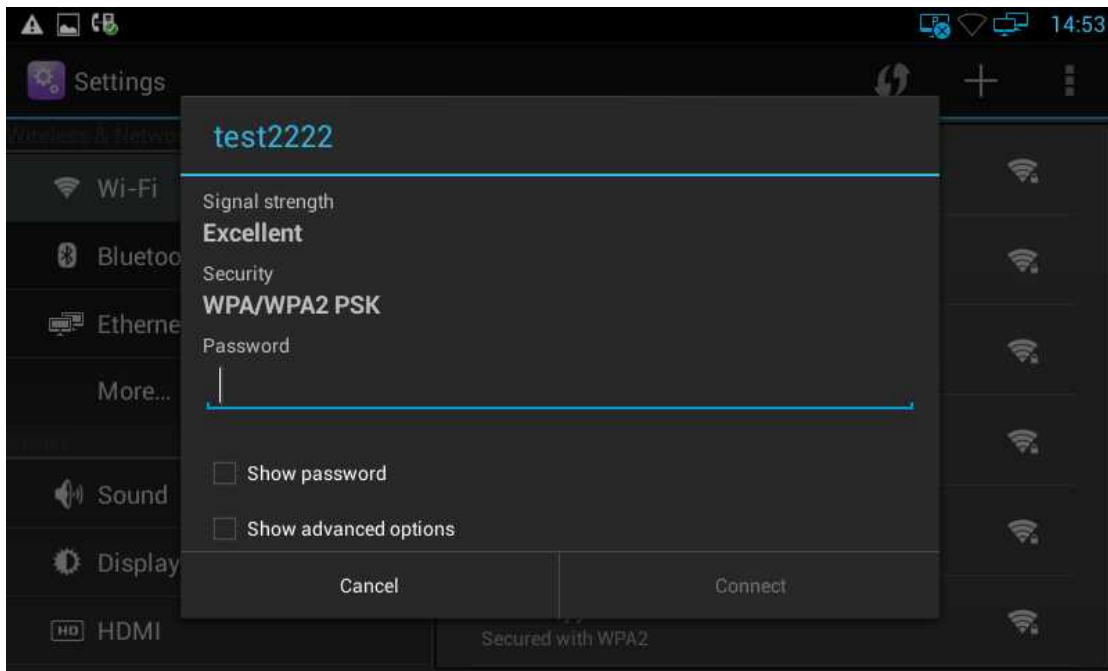

4) check Show advanced options, you can set Proxy server and IP mode.

- Proxy Settings

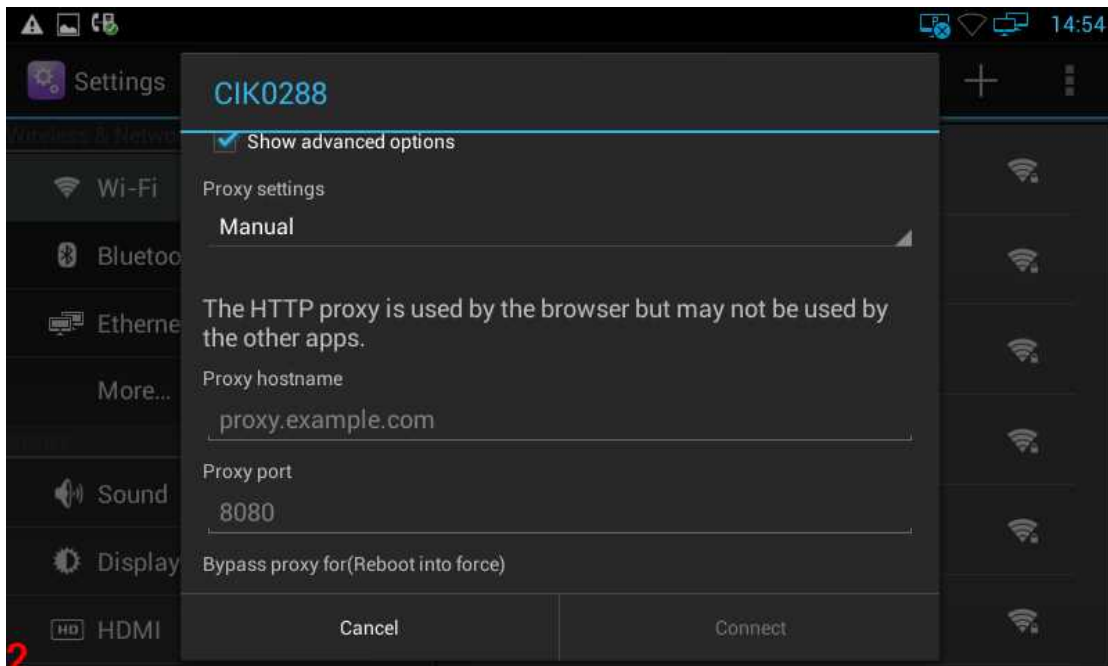

- IP settings(Static IP):

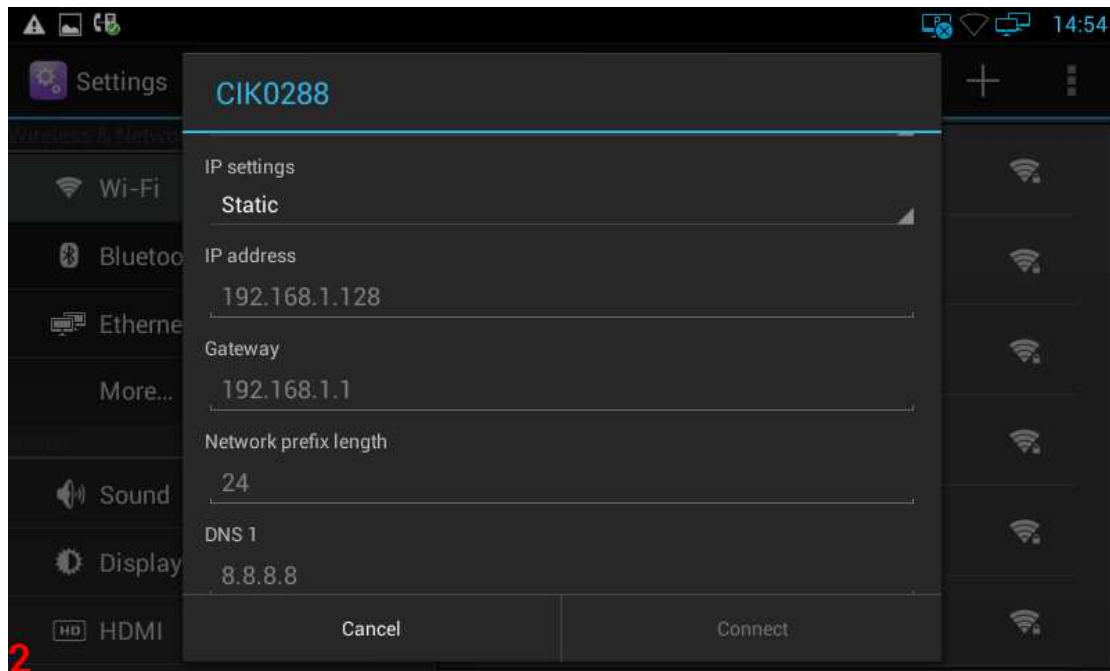



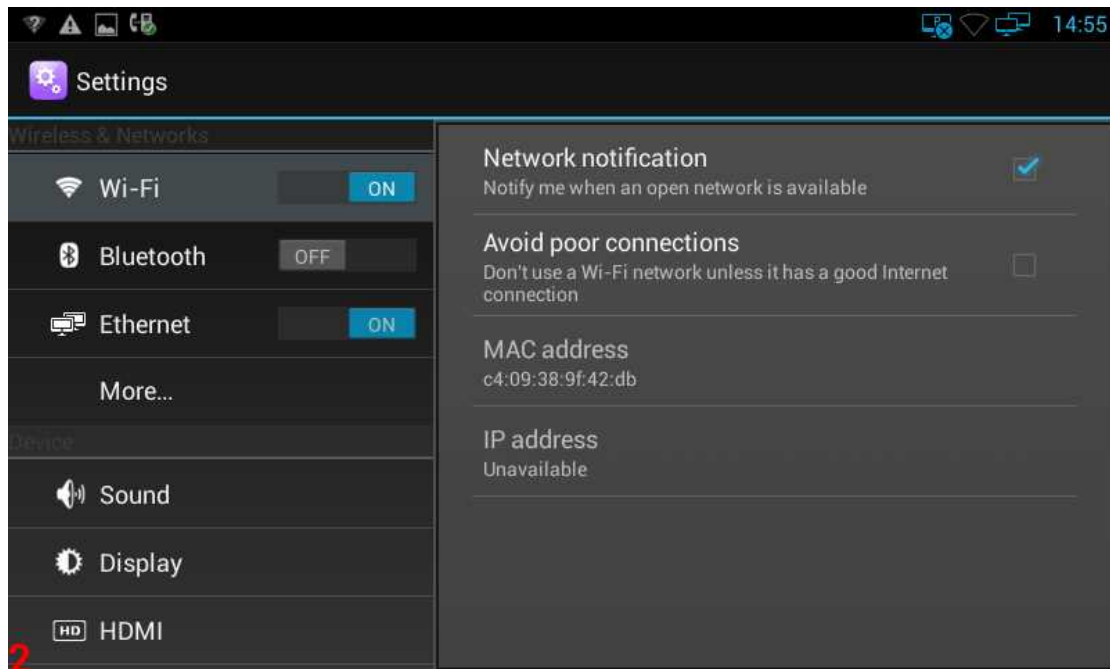



- 5) Long press on the connected Wi-Fi AP, it will pop-up a dialog box, you can forget the network or modify the network. Long press on the non-connected Wi-Fi AP, it will pop up a dialog box, and you can click and connect to network.
- 6) Click WPS(Wi-Fi Protected Setup) button, if the wireless router has WPS function, and the router WPS button is pressed, the video phone will be able to connect to the Wi-Fi without entering a password.
- 7) Press “+”symbol, you can add a SSID manually.
- 8) Click Menu, you can do the operations such as: Scan(scan the new wi-fi AP), WPS Pin Entry(enter the PIN on the Router, the phone will no need to input the wi-fi password), Wi-Fi Direct and Advanced.
- 9) In Advanced Menu, shown as below:



- a. Check Network notification, it will notify you when an open network is available;
- b. Check Avoid poor connections, it will prompt that don't use a WiFi network unless it has a good internet connection;
- c. View the Wi-Fi Mac address and IP address;

4.3 SIP Account Configuration

You can select one of the following methods to enter the SIP account configuration:

- Mode 1: In the main screen, click  -> then click .
- Mode 2: In the main screen, click  -> then Click  -> and then click .
- Mode 3: Directly pick up the handset or press Speaker -> then click .
- Mode 4: Click Browser, input IP address to enter login interface. Input username: admin, password is admin, click Login into web, then click Account-Basic;

4.3.1 Add Account

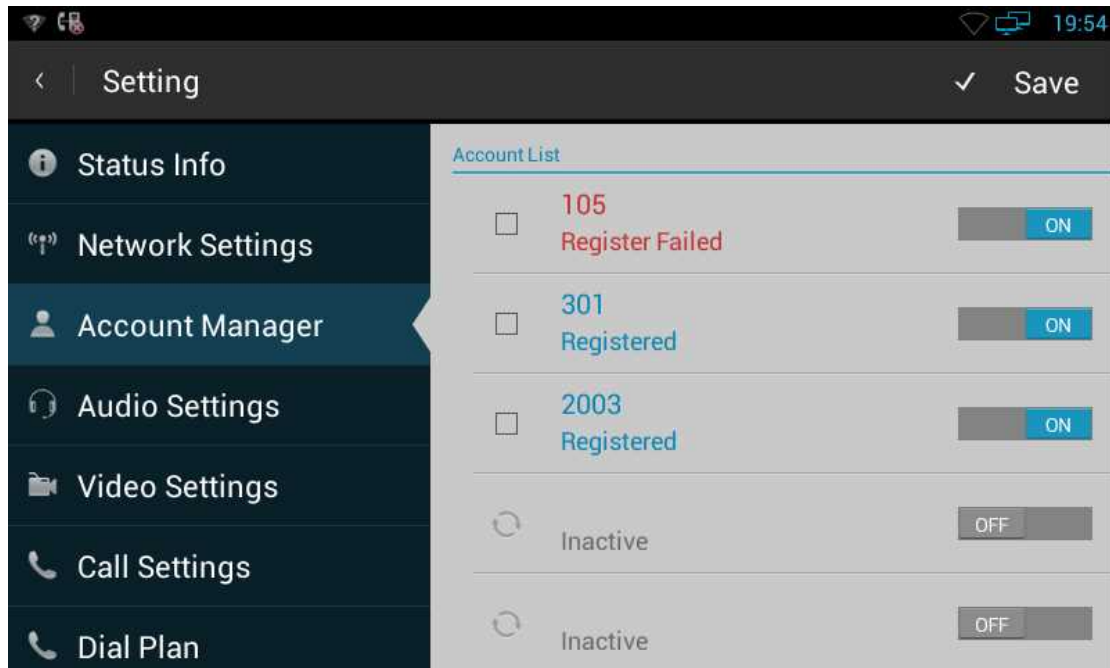

Click an account to enter Account Editor

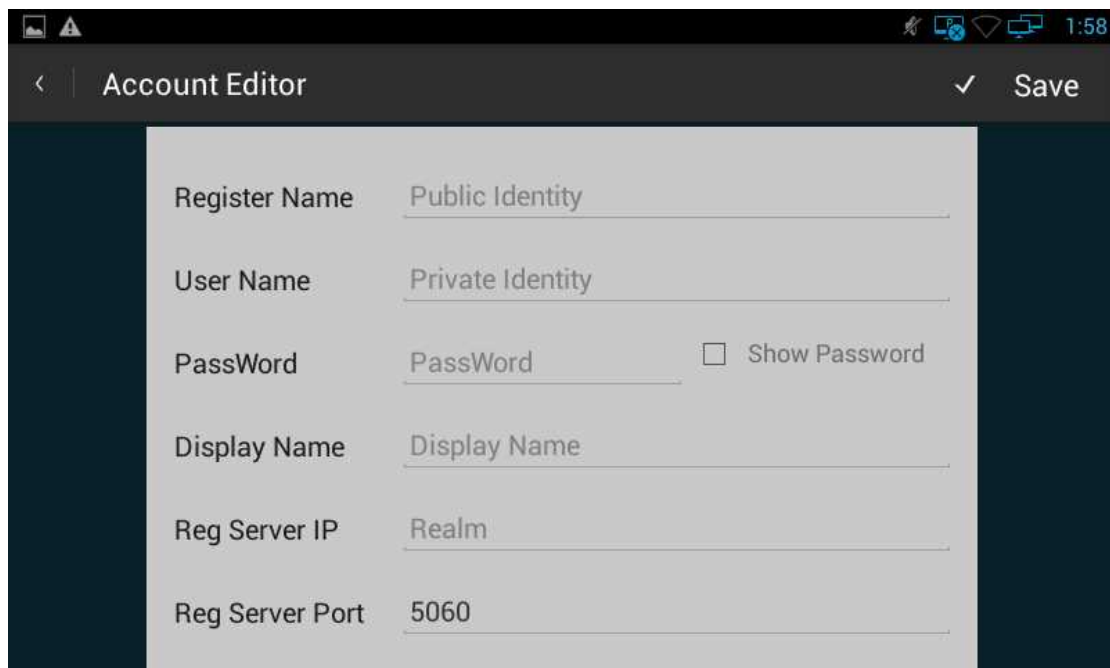

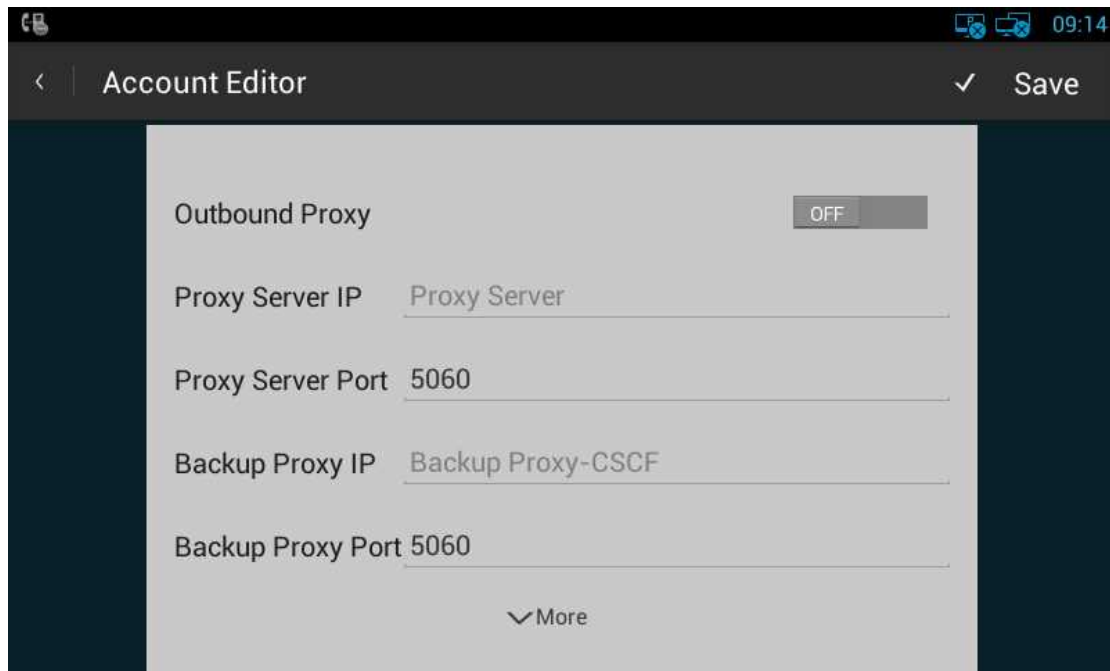



Configuration parameters are described as follows:

Parameter	Specification
Register Name	SIP Account ID provided by ISP
User Name	SIP User Name provided by ISP
Password	SIP Password provided by ISP
Display Name	SIP Display name
Reg Server IP	SIP Register Server, format: domain/IP, for example: 194.168.1.2
Reg Server Port	The default port is 5060.
Proxy Server IP	SIP Proxy Server, format: domain/IP, for example: 194.168.1.2
Proxy Server Port	The default port is 5060.
Backup Proxy IP	SIP Backup Proxy Server, format: domain/IP, for example: 194.168.1.2
Backup Proxy Port	The default port is 5060.

After all the parameters are configured, Click "save" button to save the configurations, then the sip account is added successfully, then active the account.

4.3.2 SIP Account ON/OFF

After SIP account is configured and registered successfully, it will display the prompt "Registered" in the Account Manager, and the icon  will be displayed on the status bar.

If you want to disable the account, please click .

If the sip account is failed to register, the failure code will be displayed under the account, and then you can check with the account configuration or network connection. As shown below:

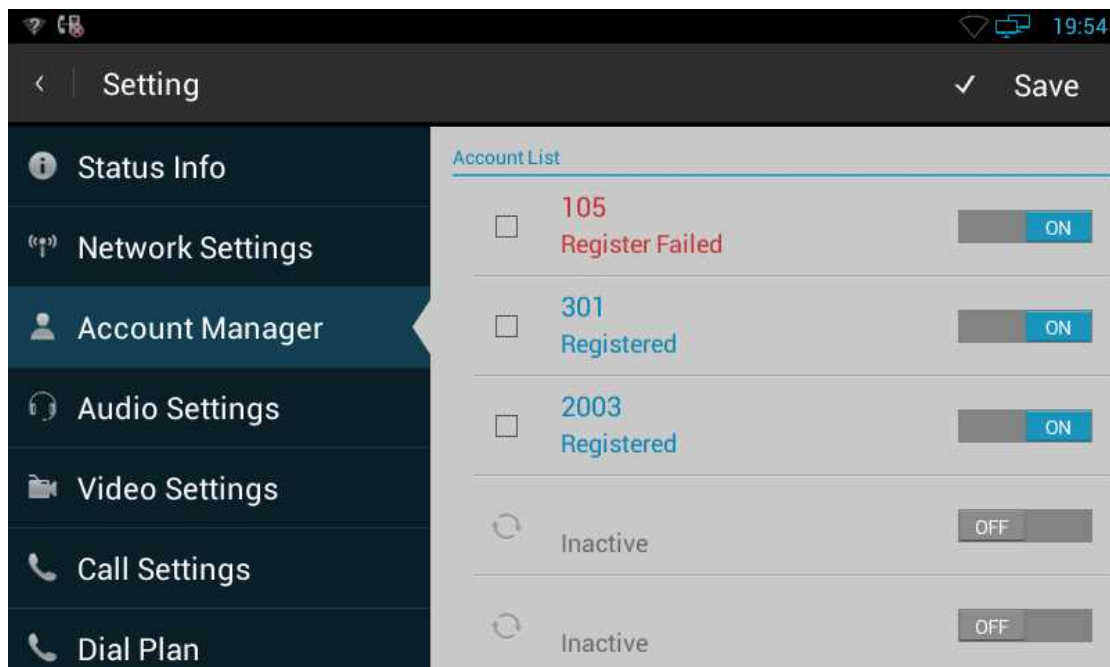

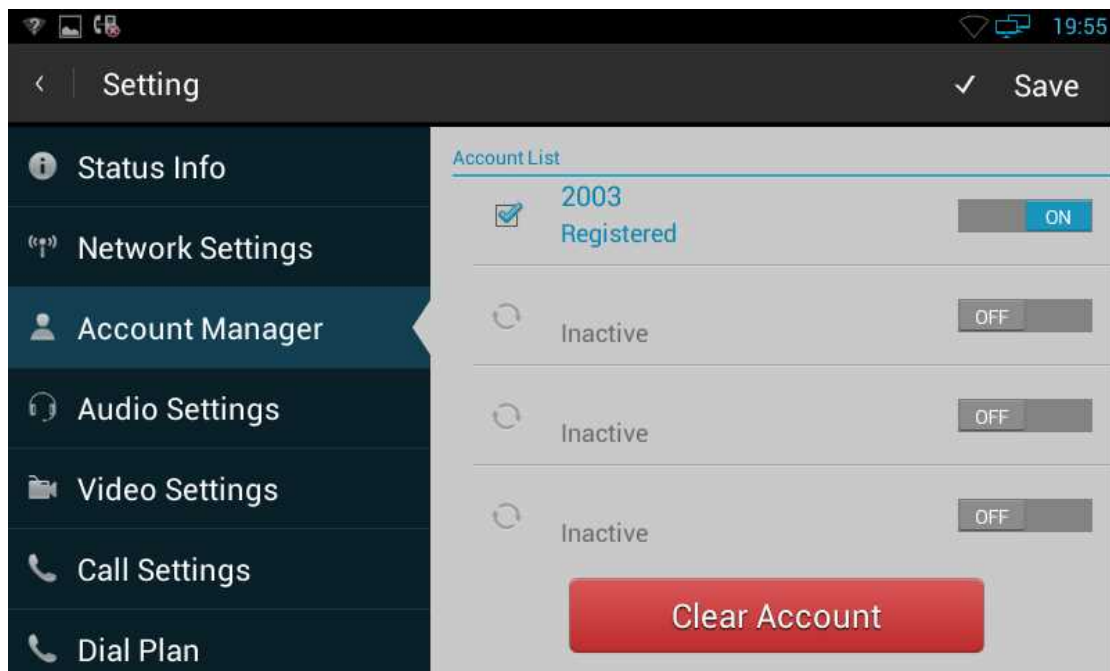

4.3.3 Modify/Remove SIP Account

- 1) Modify the sip account: Directly click the account to modify;
- 2) Remove the sip account: Click the box of the account which you want to delete, and then press "Clear Account".



4.4 Sound

You can select one of the following methods to enter the Sound configuration:

- Mode 1: In the main screen, press "Menu" key on the hard keyboard-> System Settings-> Sound.
- Mode 2: In the main screen, click  -> Settings -> Sound.
- Mode 3: Drag down the status bar, click shortcut icon  on the status bar ->SETTINGS ->Sound.

Configuration page is shown as below:

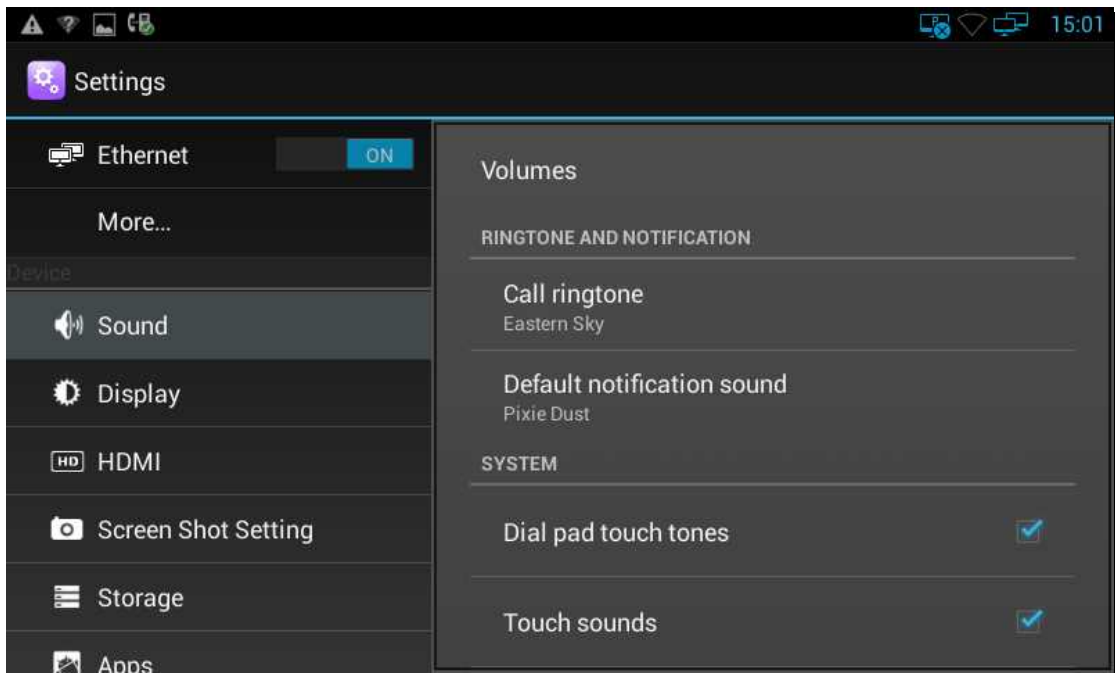

Including Volume, Ringtone and Notification, Dial pad touch tones and Touch sound.

4.4.1 Silent Mode

Long press the Power button, then choose Silent mode in the pop-up menu. In addition to the media and the alarm sound, the rest sound is mute. As shown in the picture below:

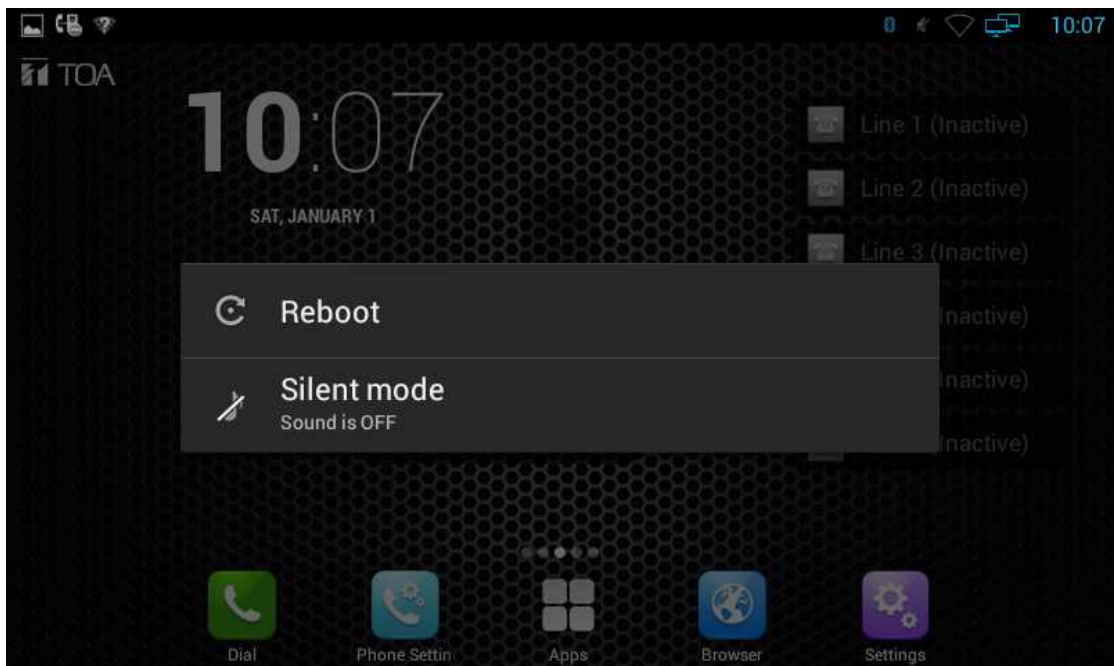

4.4.2 Volumes

In Sound configuration page, click "Volumes", the volume configure is shown as below:

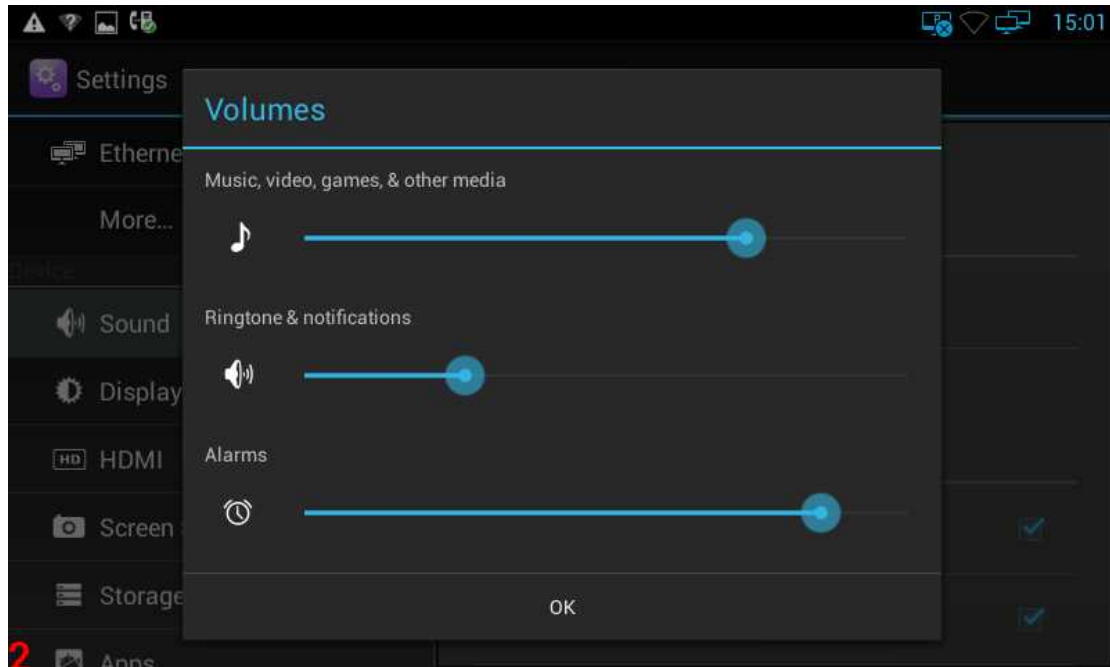

- Volume options include ringtones and notifications, Media, Alarm clock.
- You can hold and drag the slide button or just directly click a volume location to adjust the volume. Finally click "OK" button to save.
- The volume settings, you can also press the keyboard "volume+ -" button to increase or decrease the volume. Usually, "volume + -" button is to adjust for ringtone or notification volume, but in the broadcast media, pressing "volume + -" button is to adjust for media volume.

4.4.3 Ringtone

The ringtone settings, including the default ringtone and default notification tone.

In the sound interface, select the default ringtone or default notification tone, and then click the ringtone you want to set, after the selection, it will be a short play ring. Finally, click "OK".

4.4.4 System Sound

If you want to enable Dial pad touch tones and Touch sounds, please go to Sound configuration page to click the correspond sound. Dial pad touch tones and Touch sounds are enabled in default configuration.

4.5 Audio Settings

To setup the corresponding audio parameters and Volume.

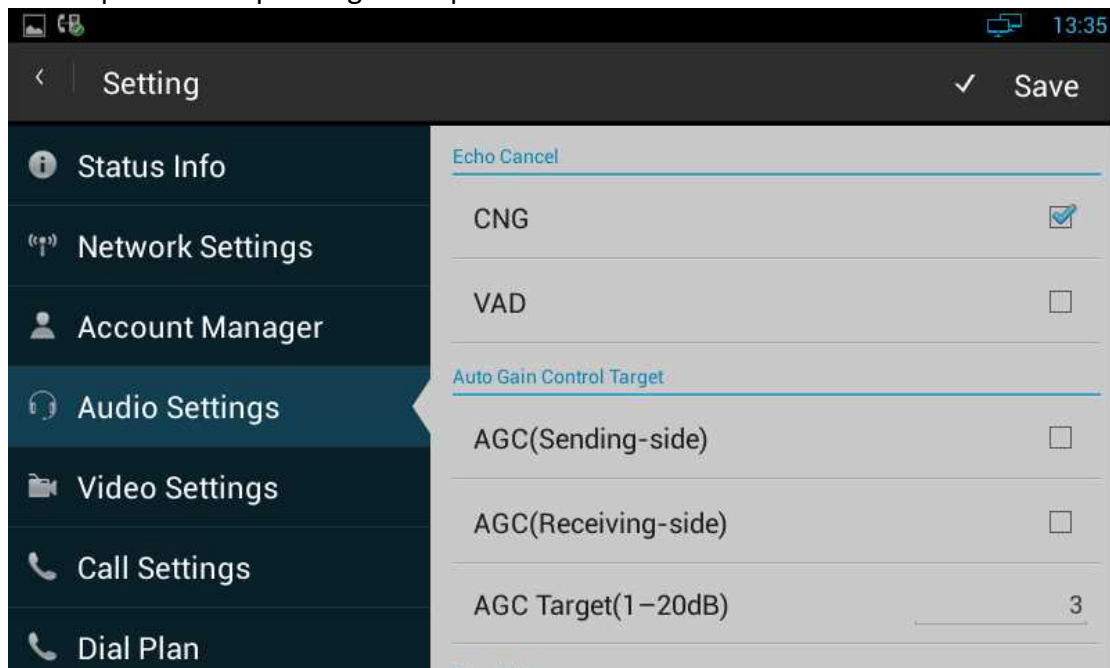

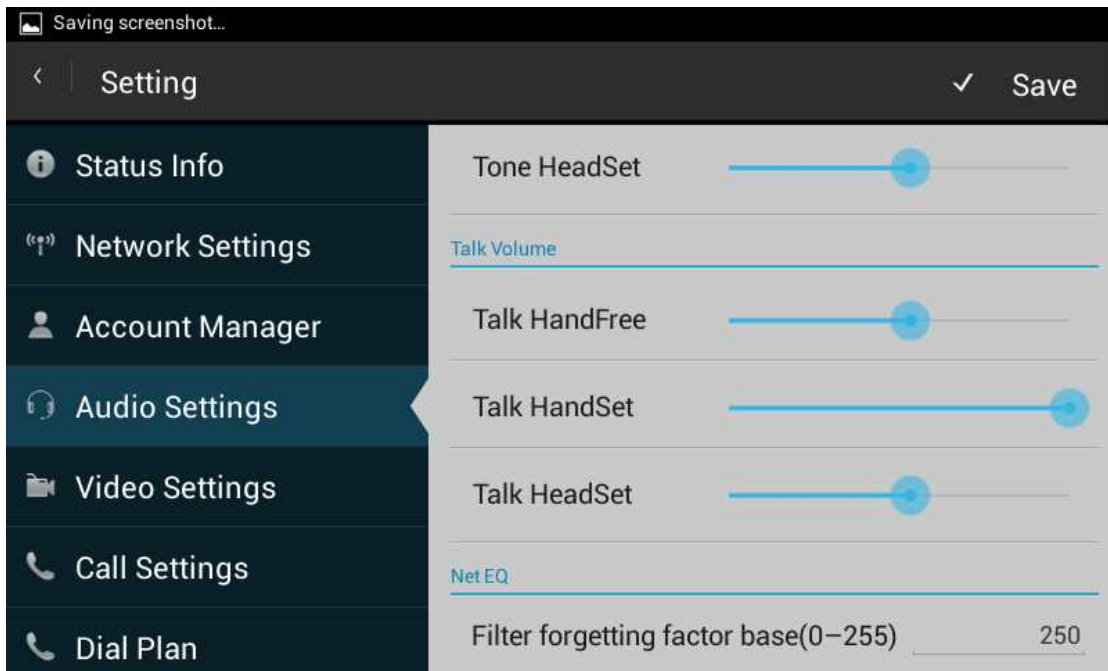

4.6 Video Settings

To configure the video corresponding parameters.

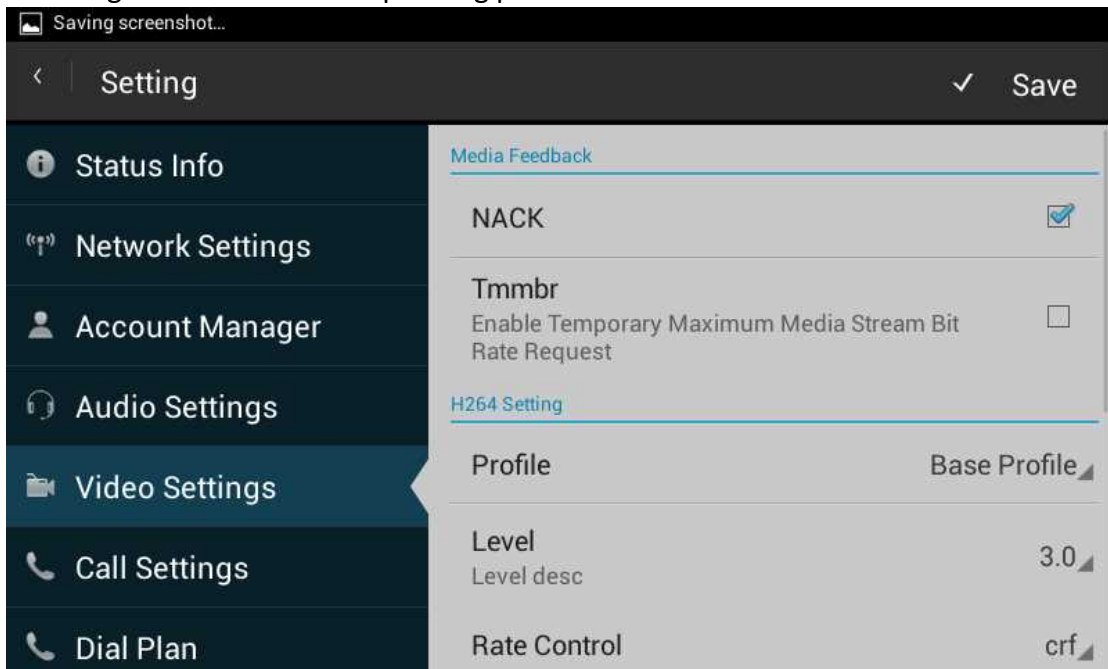

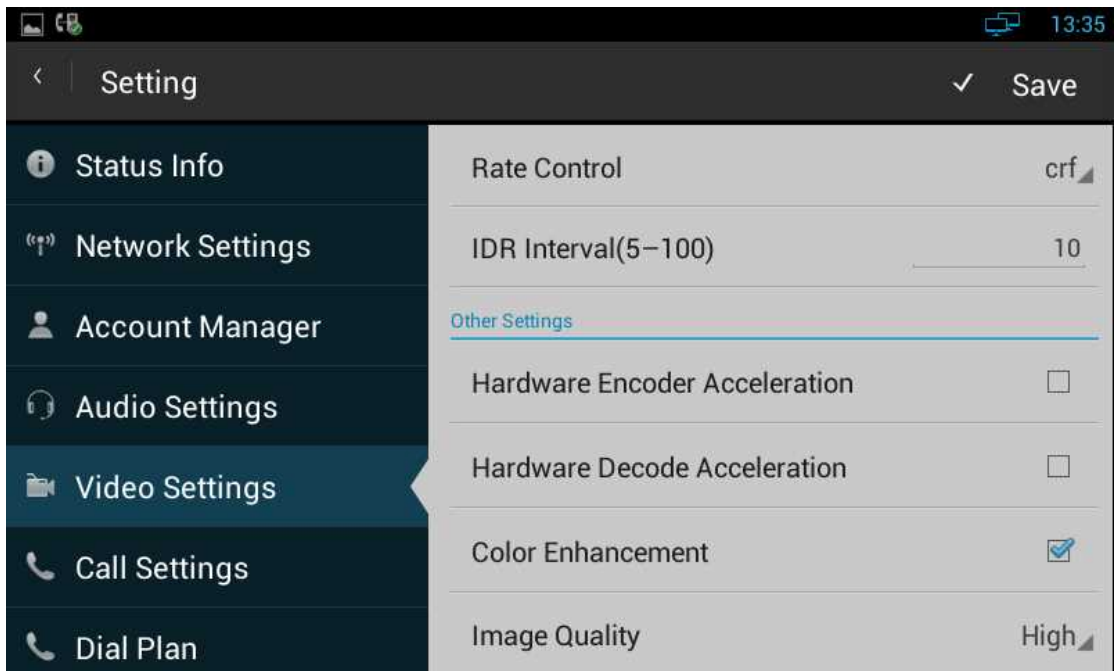

4.7 Call Settings

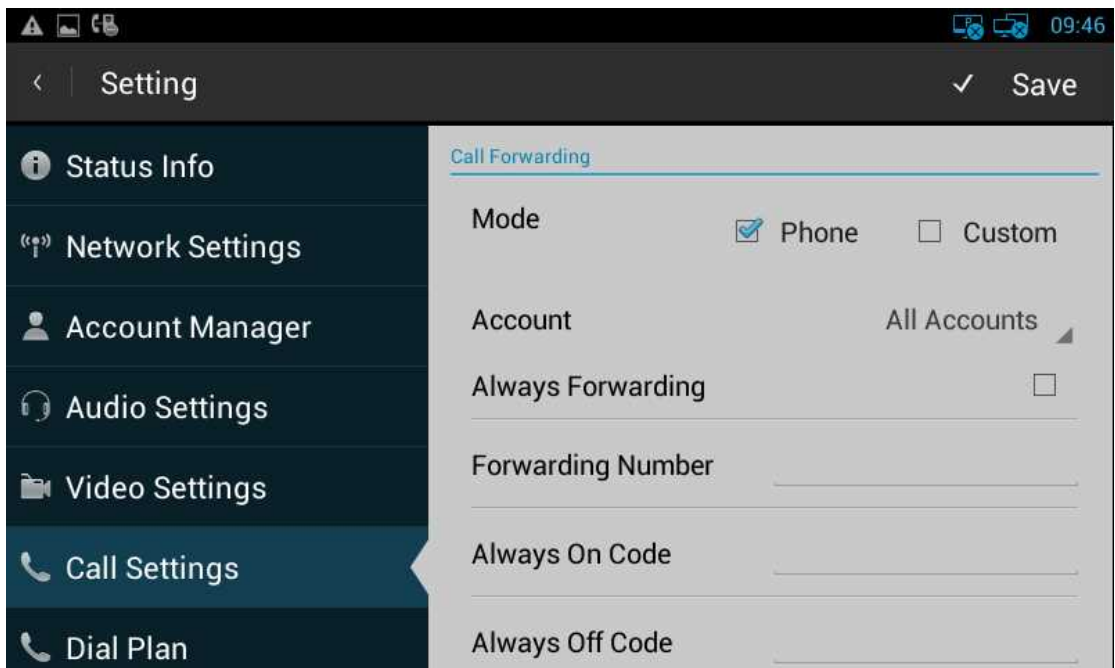

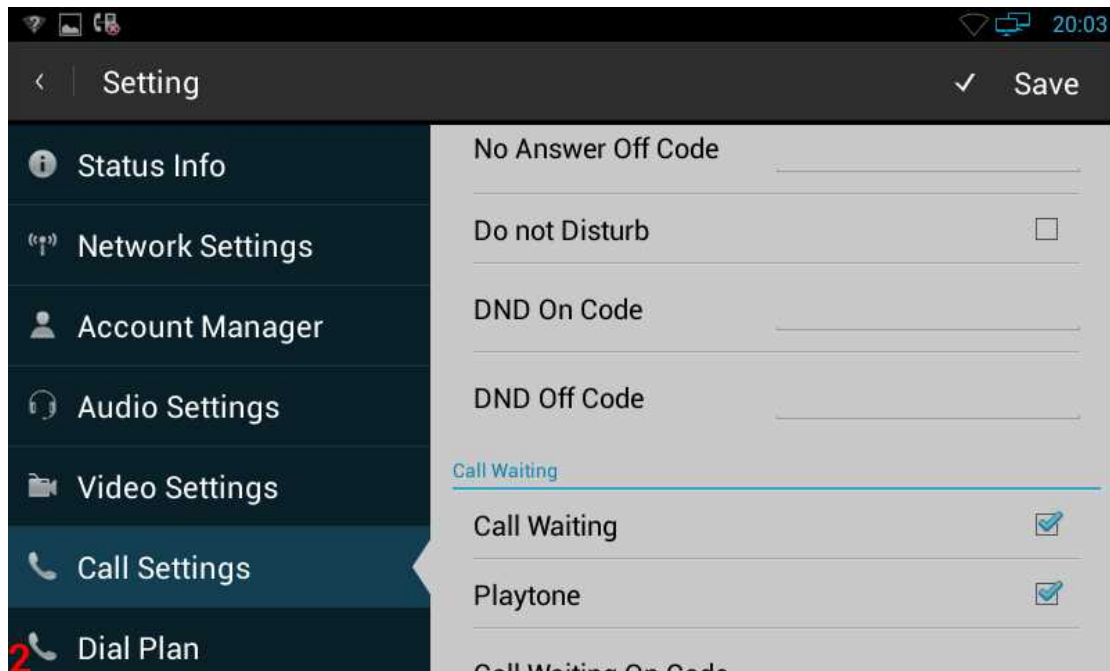

4.7.1 Do Not Disturb

DND function is to prevent foreign phone from disturbing, if open DND, external phone call is unable to call in, turned off by default.

Configuration on the phone:

- 1.Phone Settings-> Call Settings-> DND
- 2.Select the desired account.
- 3.Enable Do not Disturb.

4.7.2 Call Waiting

Open call waiting, if enable call waiting, after establishment of a conversation, there is a third party call in, then video phone will have a new call tips, you can choose to answer or reject the call. If you close the call waiting, then the third party cannot call in, will prompt a busy tone, turned on by default.

Configuration on the phone:

- 1.Phone Settings->Call Settings->Call Waiting
- 2.Enable Call Waiting.

4.7.3 Always forwarding & Forwarding Number

All the incoming calls will be forwarded unconditionally to specified number.

Configuration on the phone:

1. Phone Settings->Call Settings->Call Forwarding-> Always Forwarding
2. Select the desired account.
3. Enable Always Number.
4. Input the number you want to forward.

4.7.4 Call forwarding busy & Forwarding Number

The incoming calls will be forwarded to specified number when the phone is busy.

Configuration on the phone:

1. Phone Settings->Call Settings->Call Forwarding->Call Forwarding Busy
2. Select the desired account.
3. Enable Call Forwarding Busy.
4. Input the number you want to forward.

4.7.5 No Answer Forwarding & Forwarding Number

The incoming calls will be forwarded to the specified number when the ring tone is time out without answer.

Configuration on the phone:

1. Phone Settings->Call Settings->Call Forwarding->No Answer Forwarding
2. Select the desired account.
3. Enable No Answer Forwarding.
4. Input the number you want to forward.

4.7.6 Time out

Setup the no answer forwarding time. When the call is beyond the time(the default is 30 seconds)without answer ,it will transfer to the target number.

4.7.7 Playtone

The caller will hear the tone when waiting. Different SIP server supports different playtone.

4.7.8 Intercom

It is used to answer the incoming call automatically after users set up the intercom function. In default situation, the SIP Multimedia Station TOA N-SP80MS1 will answer the intercom incoming calling automatically and make a noise. You can set the phone to enable silent mode when picking up the intercom call so that the other will not hear you.

4.8 Dial Plan

Rules: Allow user to select Replace Rules or Dial Now to display or edit.

Rules Modify: Allow user to modify selected rules information, for replace rule, you can modify related accounts, prefix and replace.

Area Code: Area codes are also known as NPAs (Numbering Plan Areas). They usually indicate different geographical areas within one country. If entered numbers match the predefined area code rule, the SIP Multimedia Station will automatically prefix outgoing number with area code.

Note: There is only one area code rule supported.

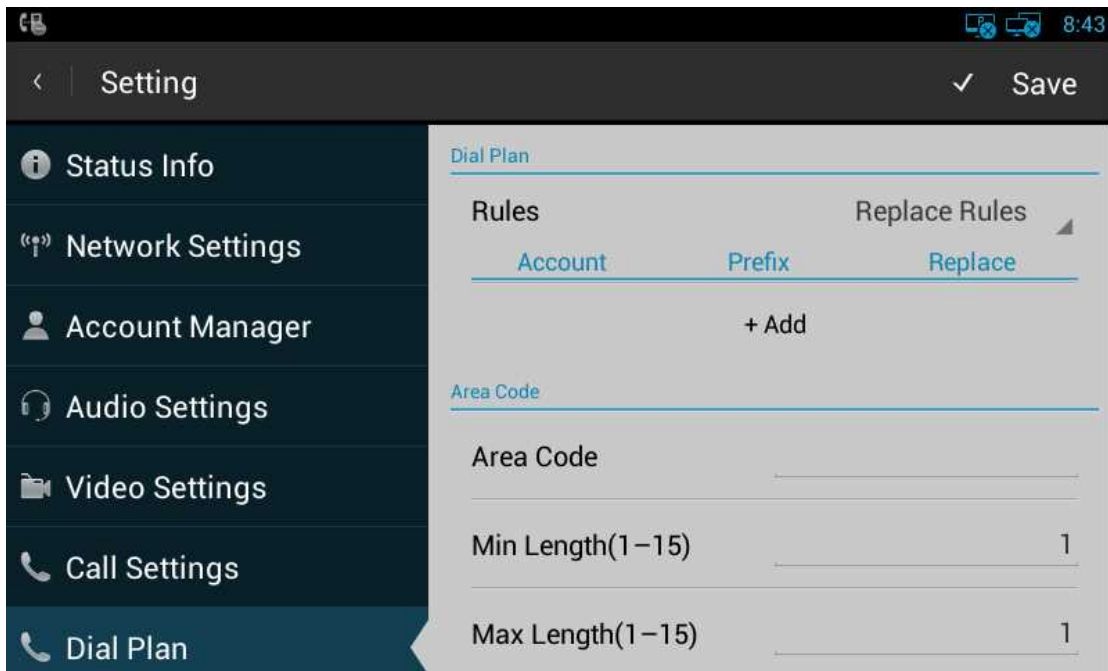

4.9 Auto Provision

N-SP80MS1 SIP Multimedia Station can be configured to resynchronize its internal configuration state to match a remote profile periodically and on power up by contacting a normal provisioning server (NPS) or an access control server (ACS). In this document, we assume that the administrator knows how to set up the NPS and ACS (DHCP, PNP, TFTP, FTP, HTTP, and HTTPS servers).

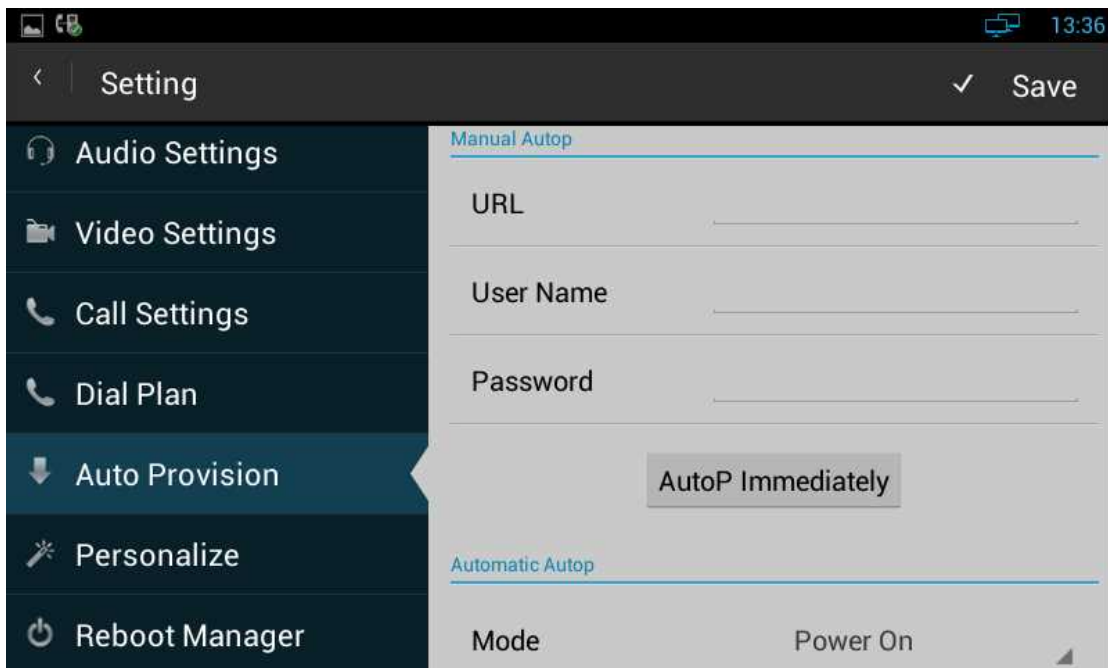

4.10 Personalize

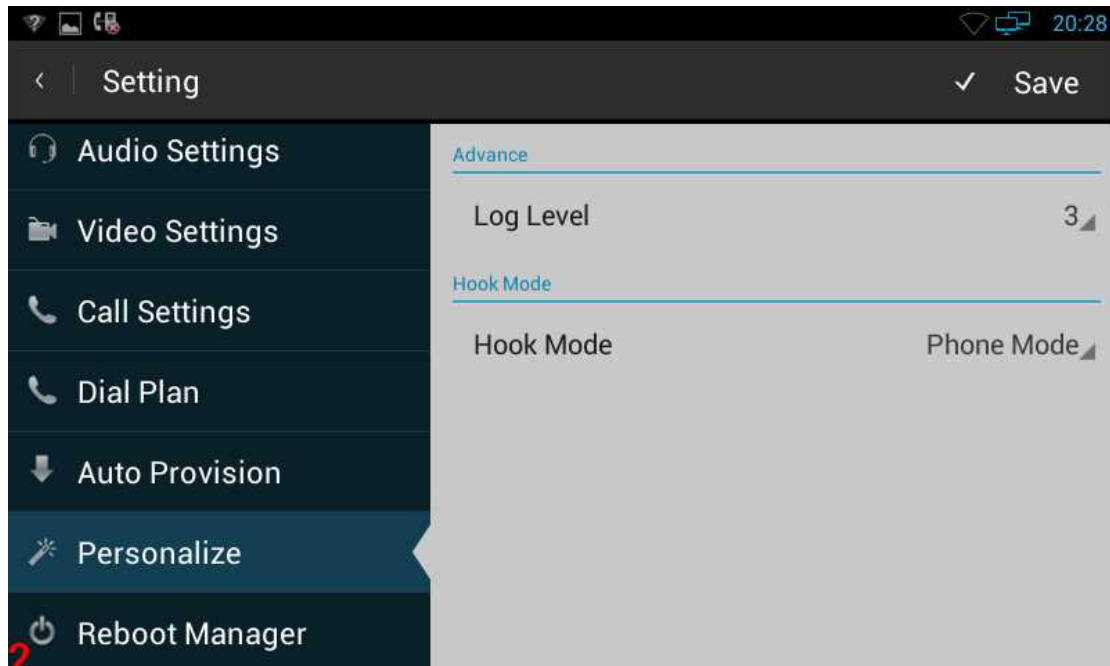

4.10.1 Log Level

The Log level is divided into seven levels: EMERG, ALERT, CRIT, ERR, WARNING, NOTICE, INFO, DEBUG, log class is from low to high. The default setting is EMERG, which is the lowest grade log.

4.10.2 Hook Mode

Hook Mode is divided into Phone Mode, Disable, App Mode, Auto Mode. The default mode is Phone Mode.

4.11 Reboot Manager

4.11.1 Reboot time

User can setup the reboot date and hour you want.

4.11.2 Status of time

If the status is enable, users can edit the reboot time you want.

4.11.3 Status of active

Enable/disable the reboot function

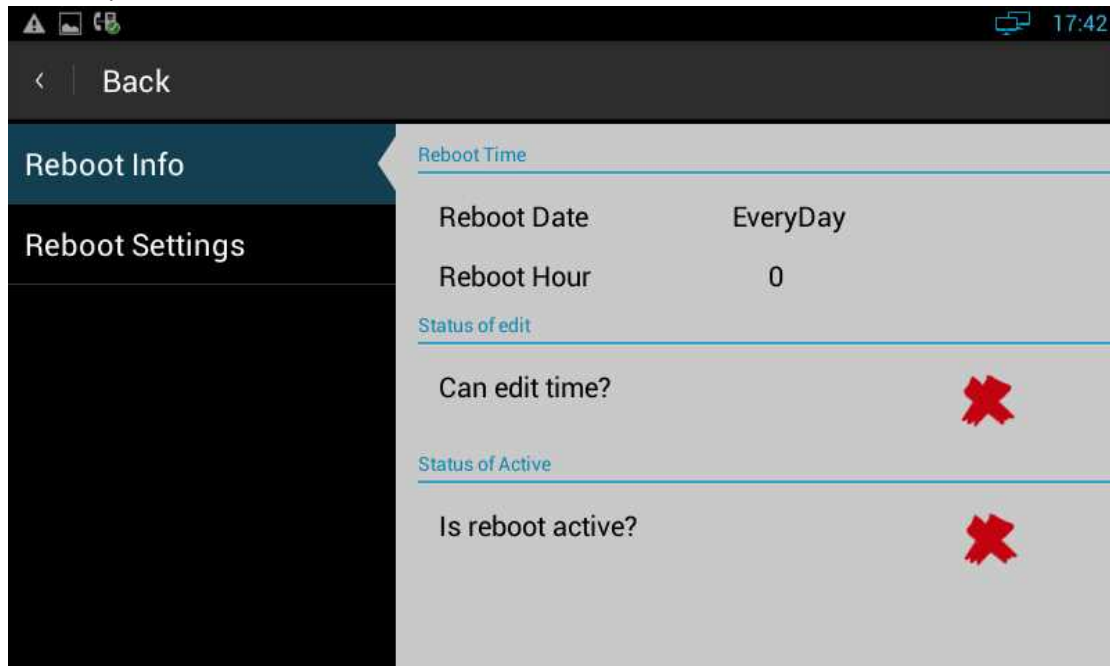



4.11.4 Reboot settings

Click the icon  to reboot.

4.12 Date & Time

You can select one of the following methods to enter Date & Time configuration:

- Mode 1: In the main screen, press "Menu" key on the hard keyboard-> System Settings-> Date & time.
- Mode 2: In the main screen, tap -> Settings-> Date & time.
- Mode 3: Drag down the status bar, click shortcut icon  on the status bar
->click SETTINGS icon -> Date & time.

The configuration page is shown as below:

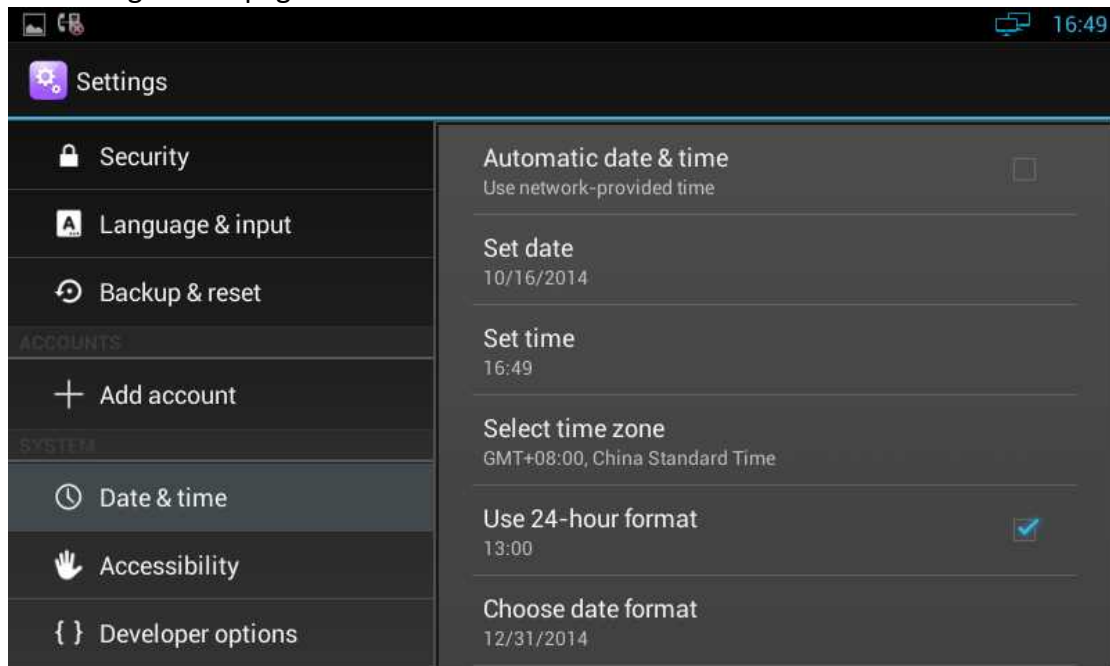

If you want to manually set the date and time, firstly, remove the click "Automatic date & time", and then set the date, time, select a time zone. Check Use 24-hour format, and then "1:00 PM" will change to "13:00".

Click "Set date", pop-up date set interface, as shown below:

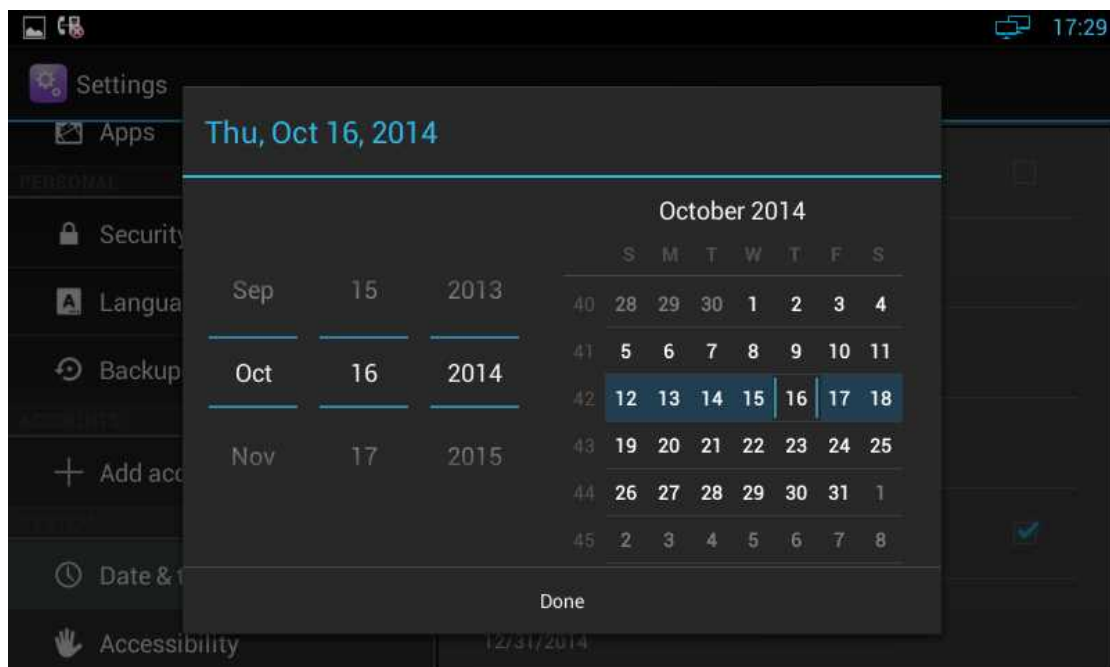

You can increase or decrease the corresponding value by dragging upper or lower, also can directly input corresponding value in input field, and then click the "Done" button.

Click "Set time, time settings, as shown below:

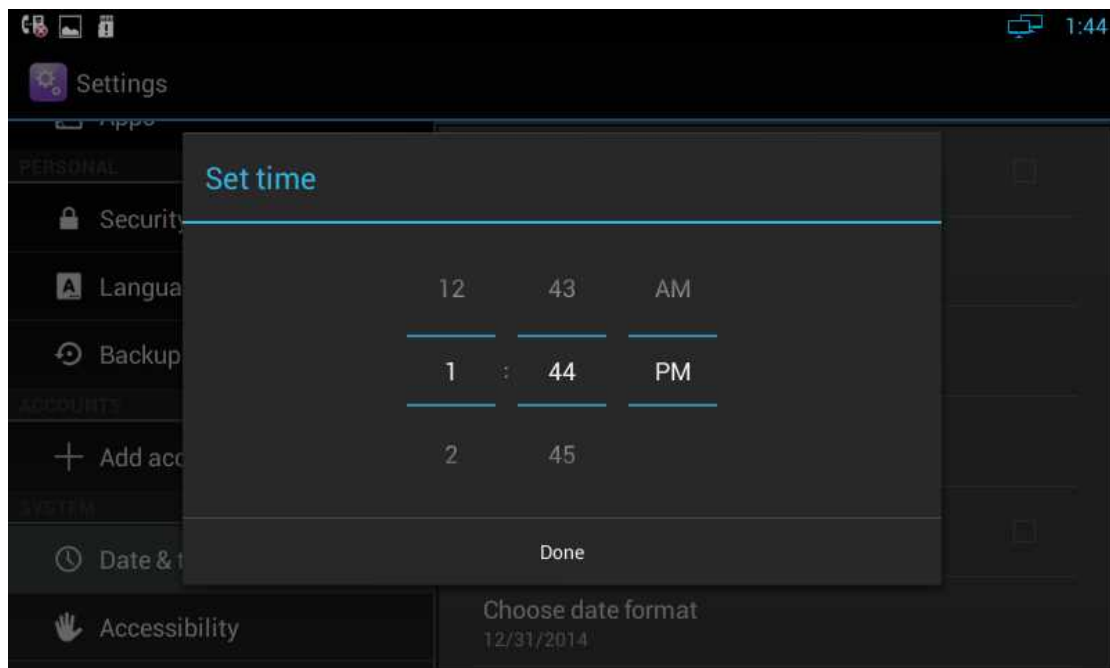

In the figure, uncheck Use 24-hour format, you can increase or decrease the corresponding time value by dragging upper and lower. Click "AM" button, it will change to "morning", and then click "PM" button, then changed back to "afternoon".

If check Use 24-hour format, time setting interface as shown below:

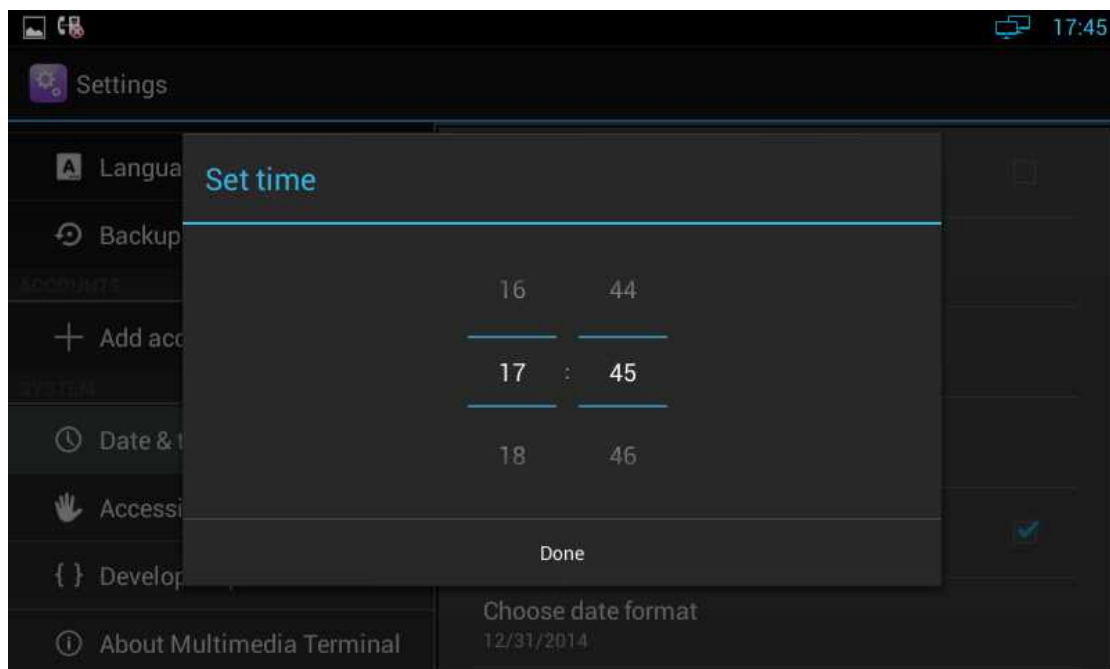

4.13 Personalization Settings

According to personalized settings, you can make the equipment more characteristic.

4.13.1 Wallpaper

You can use the following three ways to change your favorite wallpaper.

Mode 1:

1) You can choose one of the following steps to enter into the choice of wallpaper source:

- In the main screen, Press "Menu" on the keyboard-> wallpaper, it will pop up wallpaper selection interface to select a wallpaper source.
- In the main screen, Press on the blank part of desktop, it will pop up menu option, select "wallpaper".

2) Perform one of the following steps:

- In "Wallpapers", click the picture you want to set as wallpaper, and then click "Set wallpaper".
- Click "Gallery", In the library, click the corresponding picture folder, select the picture you want to set as wallpaper, then press and hold the clip frame picture, drag the clip box, crop the picture finally click "OK". When clipping, if you want to change clip size of the box, press clipping frame, the border follows the direction of the arrow to be shown in the figure, you can drag it to the border or outside the borders, to change the size of the crop box.



Mode 2:

Browse pictures in the gallery, and then follow the second step in mode 1 to set the wallpaper.

Mode 3:

- 1) Browse a picture In a browser (or pictures on the page), press and hold the picture.
- 2) Pop-up a new operation window, click on the "Set as wallpaper" and wait for a short time, you can set the picture as wallpaper.

4.13.2 Widgets

Applet can be convenient for your use, you can select from the available options

4.13.2.1 Add A Widget

- 1) In the main screen, Click , left-slide the screen, choose and add a widget. The following window:

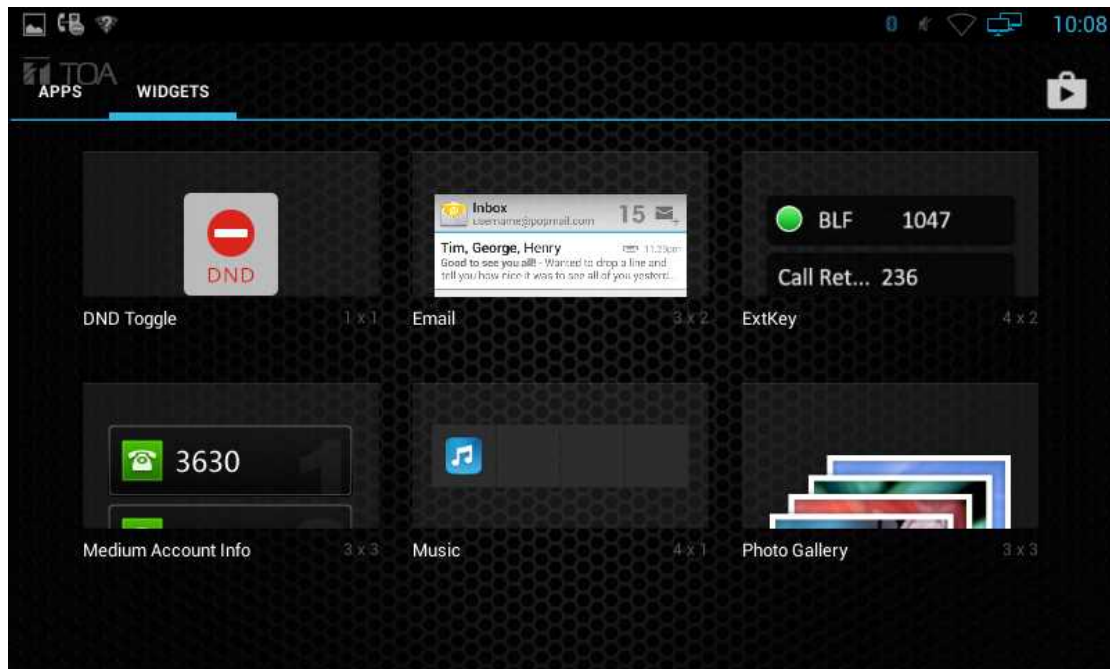

2) Each widget has indicated the name and the location, press and hold the component, put it to the designated location on the desktop.

4.13.2.2 Modify An Added Widget

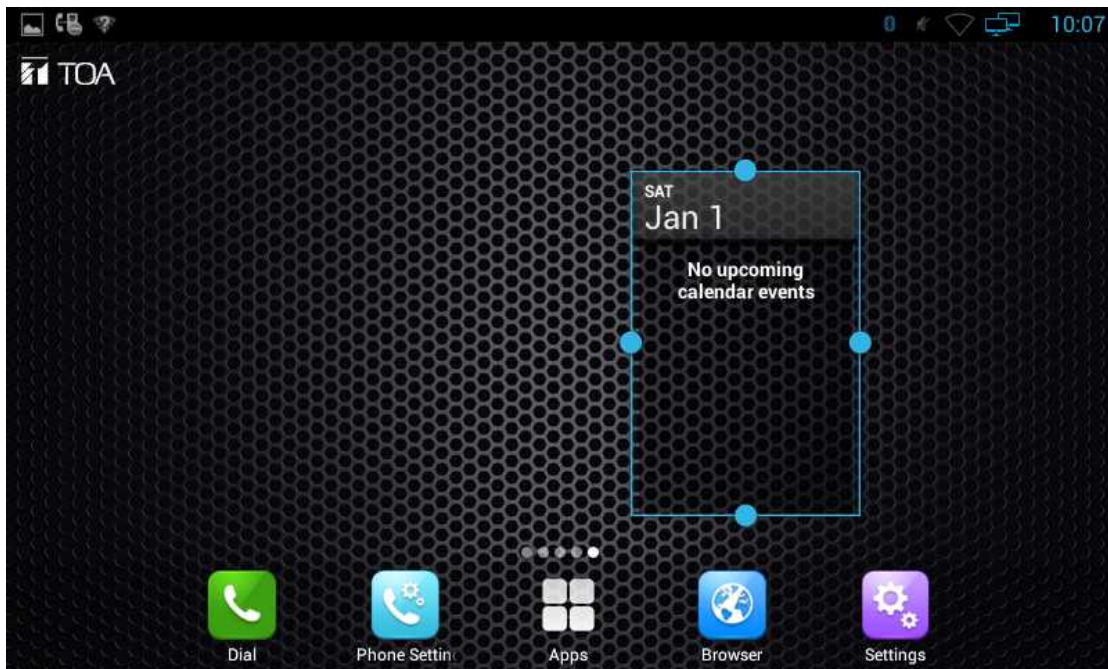

If you want to modify the location of added widgets on the desktop, hold the widget until the icon  appears on the upper left corner of the screen, you can drag the widget to the corresponding position of the desktop.

If you want to change the space size of added widgets on the desktop, press and hold the widget until the icon  appears on the upper left corner of the screen, do not move, fingers away from the screen, the widget will appear frame border, as shown below:



At this time, you can control the blue point to drag the border to change the size of the widget frame. And then only need to press “Back” button on the keyboard to save the change.

4.13.2.3 Delete A Widget

Hold the widget until the icon  appears on the upper left corner of the screen, you can drag the widget to  to delete the widget.

4.13.3 Shortcuts

You can add the shortcuts such as Application, Webpage bookmarks and the other applications to the main screen desktop.



4.13.3.1 Add A Shortcut

In the main screen, click , left-slide the screen, choose and add a shortcut, press and hold the component, put it to the designated location on the desktop.

4.13.3.2 Modify A Shortcut

If you want to modify the location of shortcut on the desktop, hold the shortcut until the icon  appears on the upper left corner of the screen, you can drag the shortcut to the corresponding position of the desktop.



4.13.3.3 Delete A Shortcut

Hold the shortcut until the icon  appears on the upper left corner of the screen, you can drag the shortcut to  to delete the shortcut.

4.13.4 Modify Extended Bar

You can modify the quick start program on the extended bar at the bottom of the screen. The default extended bar as shown below:



In the main screen, hold the shortcut until the icon  appears on the upper left corner of the screen, you can drag the shortcut to  to delete the shortcut or replace with another shortcut.

4.13.5 Ringtone

You can select the ringtone provided by video phone, and you can also download music from the Internet, and then set the favorite music as a ringtone.

If you choose the ringtone provided by video phone, please refer to Sound settings.

If you choose the music downloaded from the Internet as a ringtone, please follow the below steps:

1) Click  -> Music(App).

2) See the music list in App, select and press a music, and then In the pop-up menu options, select "Ringtone" -> "Phone"

4.14 Backup & Reset

1) Click Setting ;

2) Click "Backup & reset";

3) Click "Factory data reset";

4) Click "Reset Multimedia Terminal"

5) Click "Erase everything".

5 Function

5.1 Call Function



N-SP80MS1 supports audio calls and video calls. Please ensure that the device has registered SIP account successfully before using the call function. SIP account configuration refers to chapter 4.3

5.1.1 Make A Call

You can directly dial from the keypad, from the contact or from call records.

5.1.1.1 Dial Out Directly

1) You can choose one of the following steps to enter into the dialing interface:

- Directly pick up the handset.
- Press “Speaker” button on the keypad.
- In the main screen, Click .
- In the main screen, select  -> .

Dialing interface is shown as below:



1) By pressing the number keys on the dial interface or directly pressing the number on keypad. To delete a number, press the  on the dial interface, or press Delete button on the keypad.

2) If you want to make an audio call, please click "Audio Call"; if you want to make a video call, please click "Video Call".

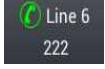
3) If you have registered a multiple of available SIP accounts, when finishing dialing, you can click line  button to choose the outgoing account for the number, as shown below:

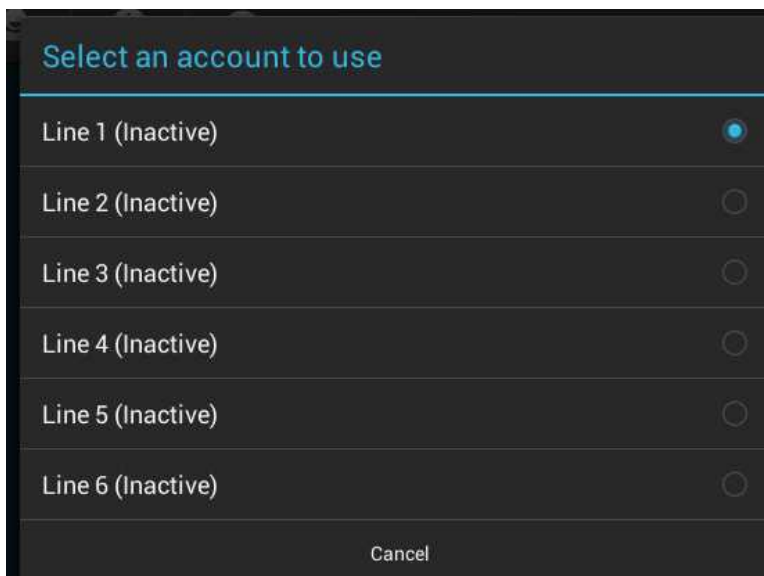

5.1.2 Dial Out From Contact

You can choose one of the following steps to enter into the contacts:

- In dialing interface, Click the icon 

Contact is shown as below:

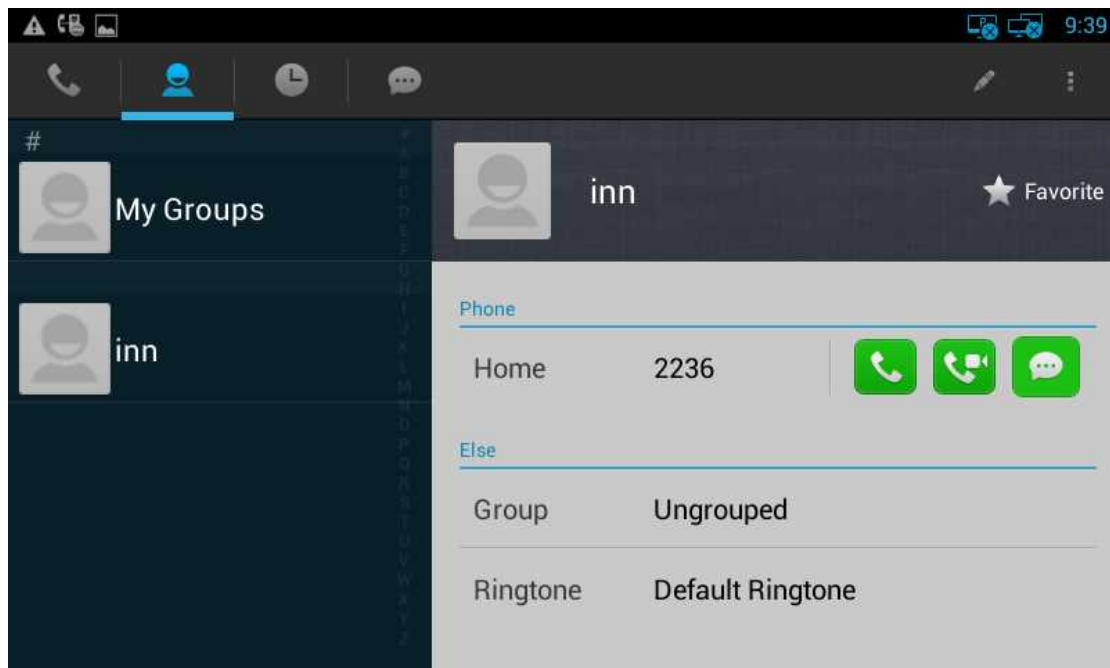



Contact supports rapid locating the contact through first letter.

- 1) Click the contact in Contacts, and you can view the details on the right side.

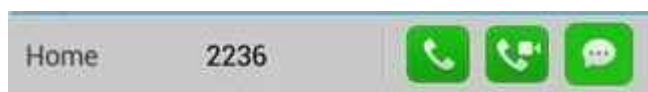
As shown in below picture:



- 2) You can click  to make an audio call, click  to make a video call, or click  to send the message.

5.1.2.1 Contacts Fuzzy Matching Query

Video phone supports contacts fuzzy matching queried, intuitive, concise dialing interface for the intelligent input, greatly reducing the number of buttons, achieve rapid, effective positioning search, avoid duplication of invalid operation, saving time.

For example, to find Inn, only press the number keys 22 to locate the contact quickly. When input no number, displaying the current call records; when input numbers, list the current matching results. Click the contact, and it will enter the telephone number to dial automatically.

5.1.3 Receive A Call

Incoming calls include audio and video calls. If the caller has been stored in the contacts, it will show the contact name, otherwise the caller number will be displayed.

5.1.3.1 Answer A Call

1) Answer an audio call

When receiving an audio call, as shown below:

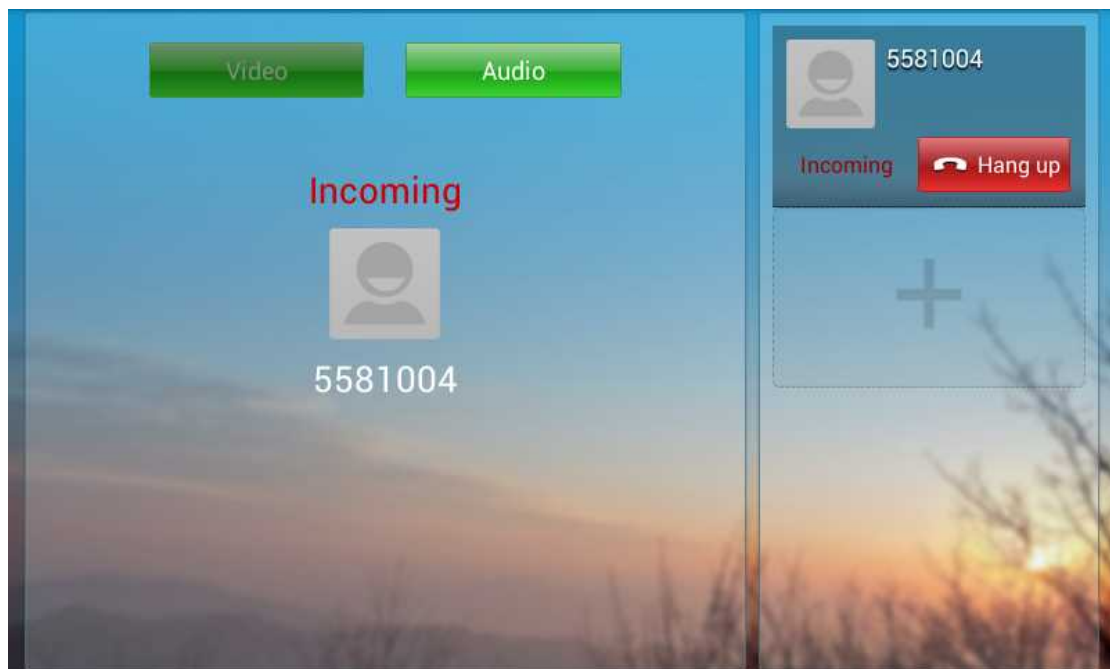

Click "Audio" or pick up the phone to answer.

2) Answer a video call

When receiving a video call, as shown below:

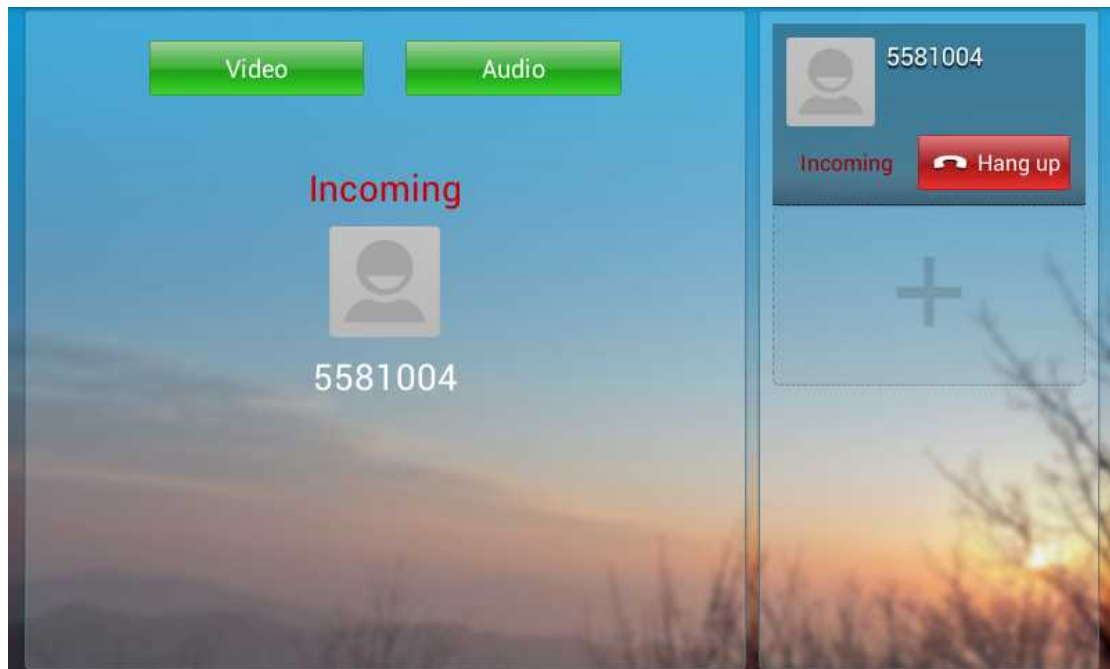

Click "Audio" to establish the audio call, and video is not visible; click "Video" to establish the video call, and video is visible. Pick up the handset to answer the call as a video call.

3) Answer a video invite

During an audio call, if a video invite is requested, it will pop up the following window:

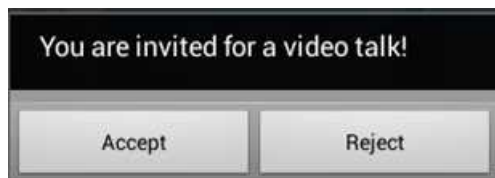

Click "Accept" to accept the video invite, and then the call will change to video call; Click "Reject" to reject the video invite, audio call will retain. 10s without any operation, the video invite will terminate.

5.1.3.2 Reject A Call

If you want to reject a call, click  in calling interface.







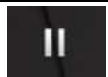

If you want to reject a call from a number, you can add the number to the blacklist.

5.1.4 Call Options

Call options as shown below:



Call options are described as below:



	Click the button to hold the current call.
	Click the button to resume the current call.
	Mute
	Click to switch to video call
	Click to switch to audio call
	Click to switch to Speaker
	Click to switch to handset
	Extended function
	Function under development

5.1.4.1 Dialing Interface

Click the " keyboard" in the conversation, screen will appear the soft keyboard. Input the number by soft keyboard or keypad on the phone.

5.1.4.2 Video Options

During video call you can switch picture through the button on the video interface.

	Switch to full screen
	View local video
	View the other part video

5.1.4.3 Multiple Calls

- The Phone supports more than 3 line calls. The line information is on the right side of call interface.
- During a call, you can click on the button  to add a new call. And when click on this button, the current call will be hold.
- During a call, you can click on any line in the list to resume the call.

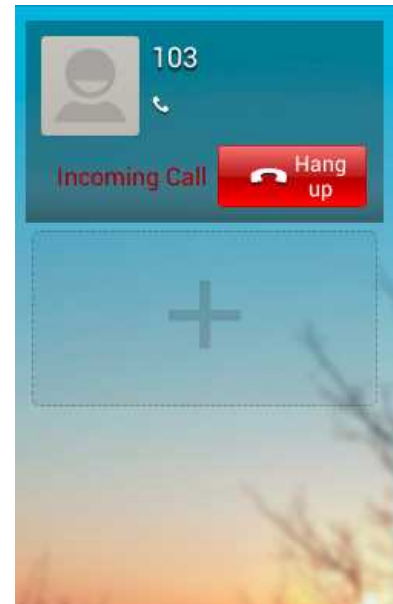



5.1.5 Call Records

5.1.5.1 View Call Records

When got a missed call, the screen will display the missed call notification in above status bar. You can hold the status bar and drag down to open the notification, and then click the missed call notification to view call records.

You can also directly through the dialing interface to view call records:

- 1) In the main screen, click  or in the main screen, click  -> 

2) Click :

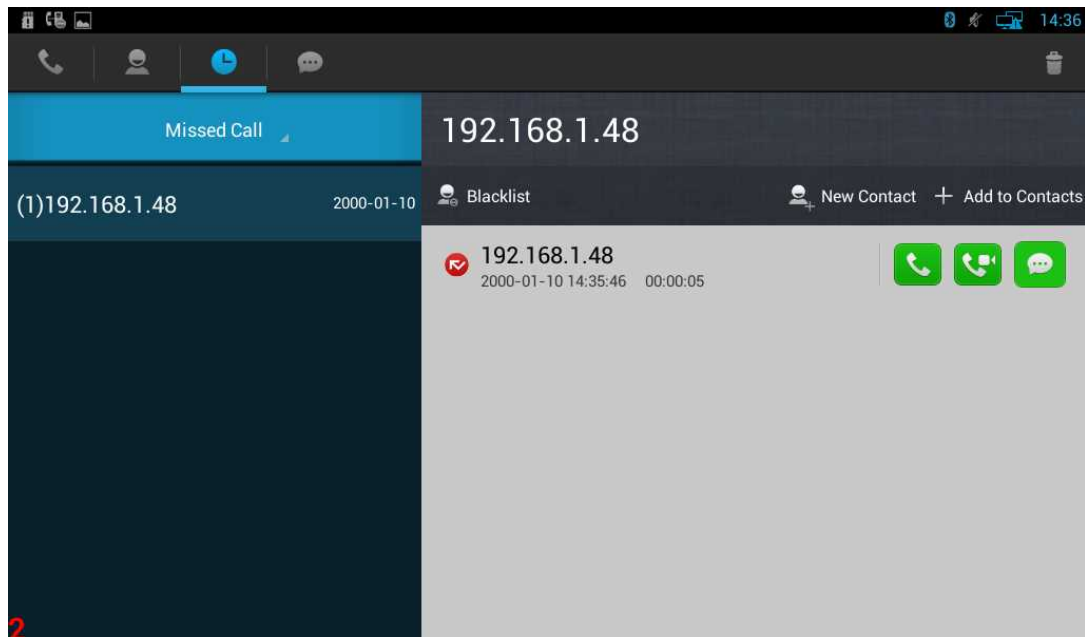



1) You can click the drop-down list  to choose the call record types, it supports for all call, missed call, received call, dialed call and forwarded call five types of call information.

2) Call records are shown on the left, and show the total number in the bracket. Click the number or contact, and you can view all the call records details on the right.

5.1.5.2 Call From Call Records

In Missed Call, Received Call, Dialed Call or Forwarded Call, you can choose one of the following steps to initiate a call:

- Click a contact or a number in the list
- If you want to initiate an audio call directly, please click the icon  in call records;
- If you want to initiate an audio call directly, please click the icon  in call records



- If you want to send a message directly, please click the icon  in call records;

5.1.5.3 Delete Call Records



1) If you want to delete one call record, steps as below:

- Long press the call record you want to delete;
- Pop-up a menu, press “Confirm” to confirm the deletion.

2) If you want to delete multiple call records, steps as below:



- Press the icon  on the top right corner, then click Remove;
- Click the call records you want to delete;
- Click 

3) If you want to delete all call records, steps as below:

- Press the icon  on the top right corner, then click Remove;
- Click  to select all records;
- Click 

5.1.5.4 Add A Contact From Call Records

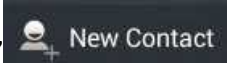
If you want to save a contact from the call records, or merge the contact into the existing contact, you can do the following operations:

- Click the number in the call records list;
- If you want to add a new contact, click “New Contact” , a new contact page will pop up.
- If you want to merge the contact into the existing contact,, click “Add to Contacts” , Choose the existing contact and then click "OK".

5.2 Contacts

You can choose the following method to enter into Contacts interface:

- Enter the dialing interface, and then click the icon

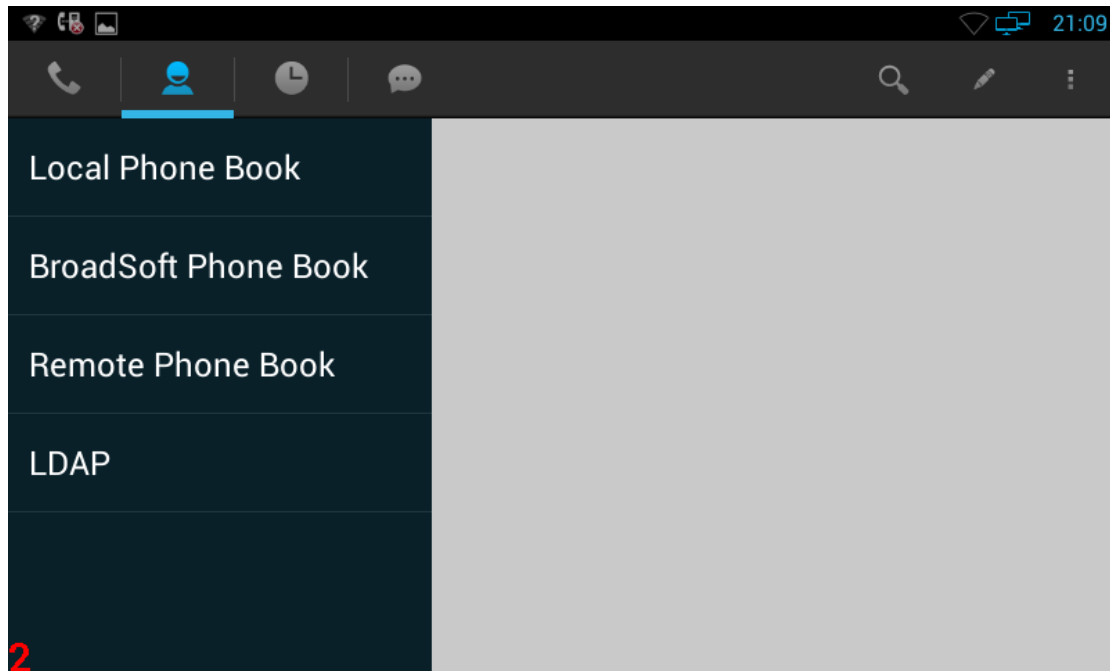





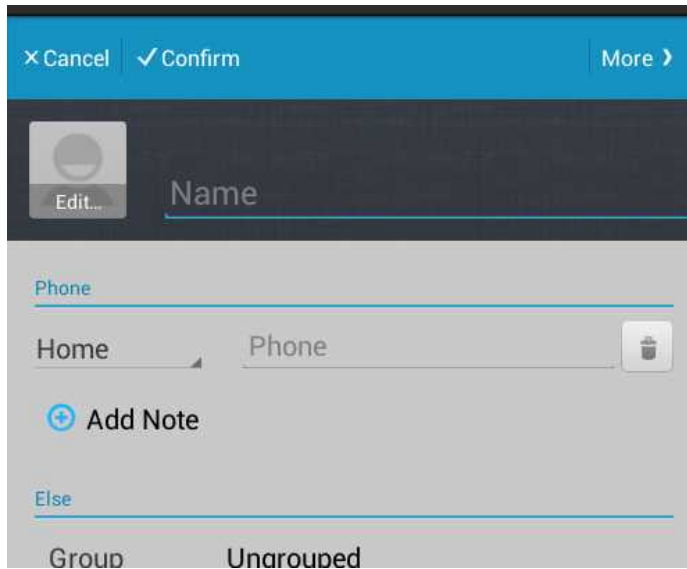

5.2.1 Local Phone Book

You can view, audio call, video call, add, edit, delete the Local contacts.

5.2.1.1 Add A New Contact

- 1) Click the icon  on the top right corner, and click “New Contact” in the drop-down window;
- 2) The new contact interface is as shown:

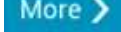

	Edit the contact photo, Browse the image from “Take Photo” or “Choose photo from Gallery”
	Delete the note
	Cancel the edit
	Save the contact
	Some more information

If you want to add some more information, please click , it will pop up the page of contact details, as shown:

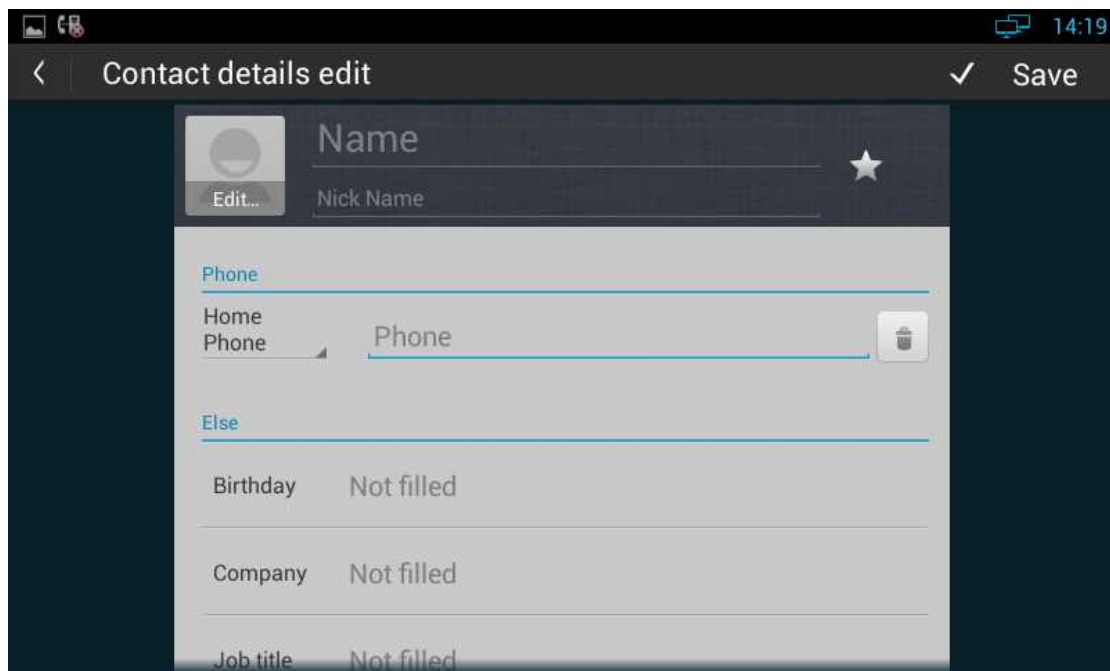

Click  to save the contact.

5.2.1.2 Modify The Contact

- 1) Select the contact you need to modify in the contact list;
- 2) Click ;
- 3) Enter into contact edit page, you can edit the contact information.

5.2.1.3 Delete The Contact

You can choose one of the following methods to delete the contacts:

- Long press the contact you need to delete from your contact list, and tap "Confirm" in the pop-up Remove Contact dialog box;
- Select the contact, click , select "Remove", click "the contact" and "Confirm" to delete.

5.2.2 Broadsoft Phone Book

To setup Broadsoft contact. For Broadsoft PhoneBook's server address, port, username and password, you need to consult your Broadsoft service provider for further information.

5.2.3 Remote Phone Book

1. Access the remote phone book, add the contacts to the local phone book from the remote phone book or make calls from the remote phone book. 5 URLs of remote phone book is available to set.
2. Set the remote phone book via web interface.
3. Access Phone Book-> Remote Phone Book.
4. Input URL of phone book.
5. Input the phone book name.
6. Click the Submit key to save.
7. Access the remote phone book via phone interface.
8. Access Book->Remote phone book.
9. Select the relevant Remote Group and press the Enter softkey. The phone will load the remote group information, and the LCD will display the contacts of this remote group.
10. Press the  key or the Back softkey to unlink.
11. Press the Book softkey to enter the Phone Book Menu.

5.2.4 LDAP

To setup LDAP contact. It often use OpenLDAP server to get the contact. For setting

details, please consult with your system administrator for further information.

5.2.5 Group

Group, it will be convenient for you to have contact group management. Contacts should at least belong to a group, the default is no group.

5.2.5.1 Add A New Group

- 1) Click ;
- 2) Choose "New group";
- 3) Input a new group name in pop-up dialog box;
- 4) Click "Confirm" to save.

5.2.5.2 Rename A Group

- 1) Click the group you want to rename in contact page;
- 2) Click ;
- 3) Input the new name you want directly;
- 4) Click "Confirm" to save.

5.2.5.3 Remove A Group

- 1) In Contact page, click the group you need to delete, and then click ;
- 2) Click "Remove", select the group you need to delete then click "OK".

(Note: the system default group cannot be deleted)

5.2.5.4 Edit A Group

- 1) In Contact page, click the group you need to edit.
- 2) Click Edit Member, or hold the existed member, it will pop up a prompt to

delete the member.

5.3 BLF

Busy Lamp Field (BLF) is used to monitor a specific user for status changes on SIP Multimedia Stations. For example, you can configure a BLF key on a supervisor's phone to monitor the phone user status (busy or idle). When the monitored user places a call, a busy indicator on the supervisor's phone indicates that the user's phone is in use.

Enter the dial interface, click BLF button.



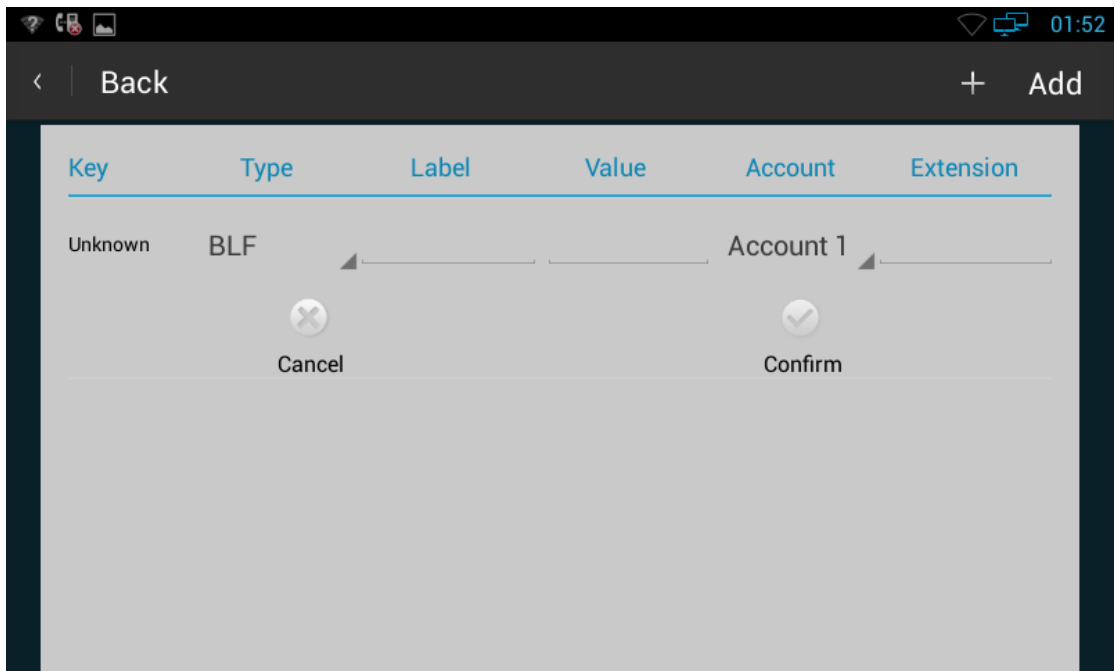

Note: After you finish BLF Key configuration, you need to drag ExtKey from the WIDGETS to the main interface. As shown below.

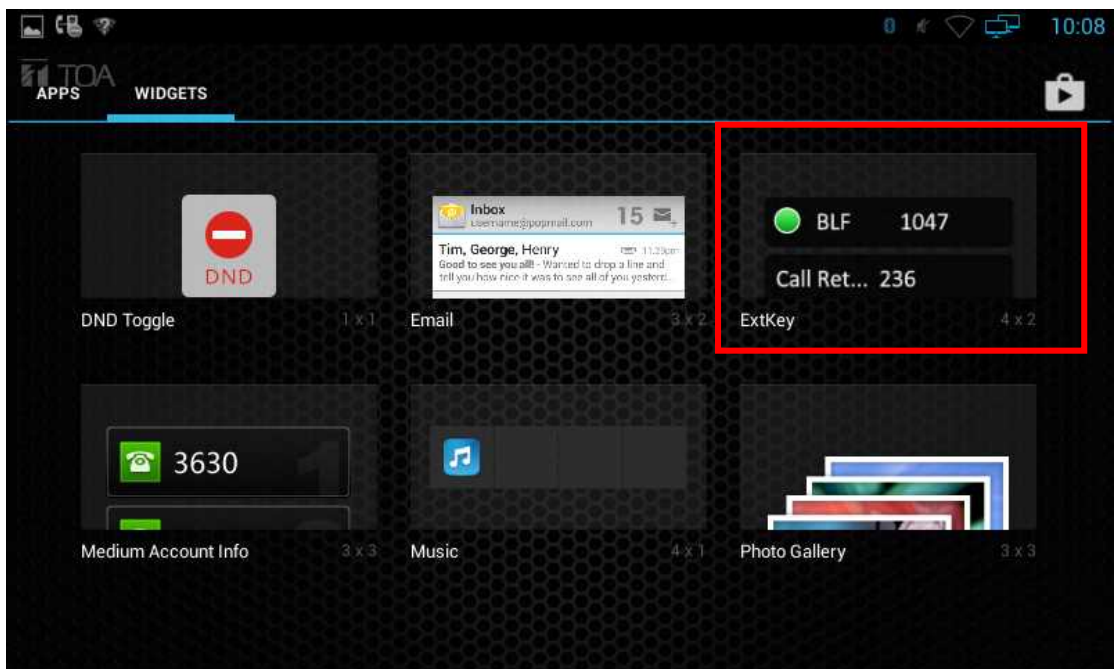



5.4 Intercom

Select Type as Intercom, enter intercom code in Value. Choose the available account. To click confirm to save.

Note: Different SIP server has different codes.

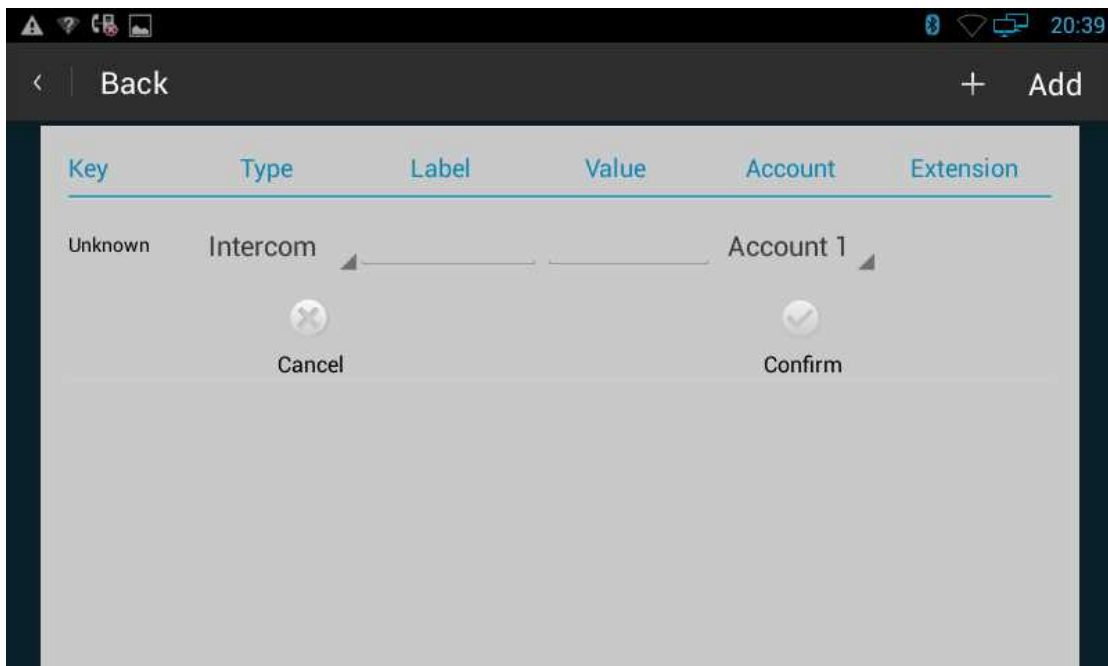

1. Press the Intercom key when the phone is available. The phone will connect the extension number of remote user automatically.

2. Answer the intercom incoming calling.
3. In default situation, the SIP Multimedia Station TOA N-SP80MS1 will answer the intercom
4. Incoming calling automatically and make a noise. You can set the phone to enable silent mode when picking up the intercom call so that the other will not hear you.

5.5 Call Return

This function can be used to call the latest dialed call record automatically.

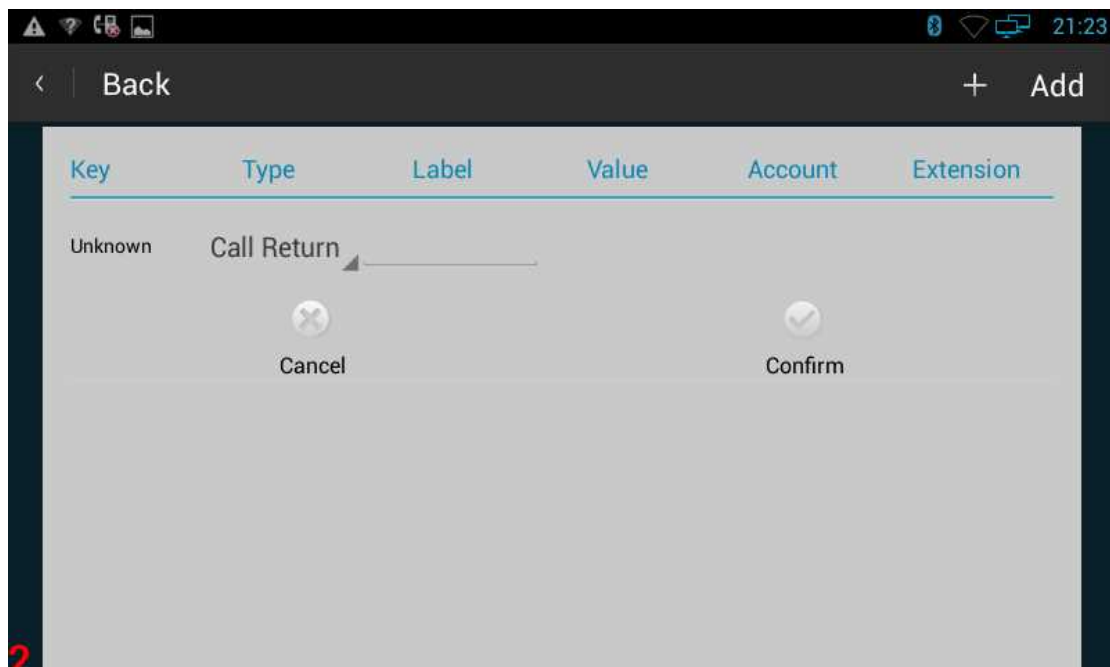

5.6 BLFList

BLF List : While using BroadSoft platform, the accounts which are monitored by the sip phone will reply the subscribe news in the form of xml list to improve efficiency.

BLF List Code :While using BroadSoft platform, configure the BLF LIST CODE, can Pick up call or Barge in call.

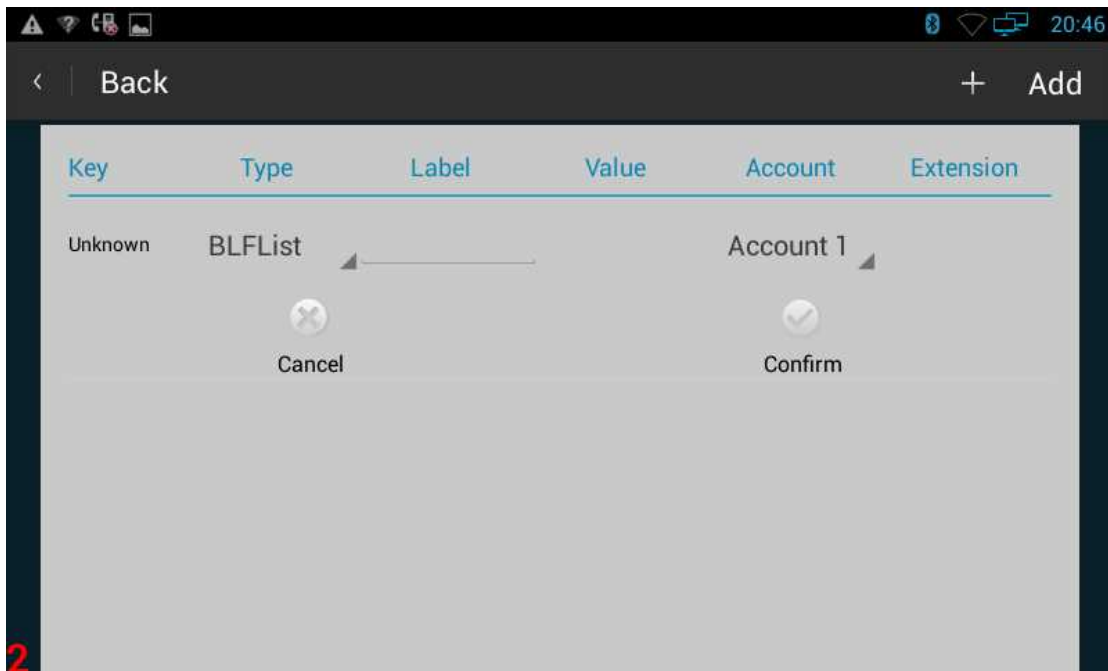

Note: BLFListCode is supported by Broadsoft platform, Please consult your administrator further information.

5.7 Pickup & Group Pickup

You can use pickup to answer other users' incoming call. The SIP Multimedia Station TOA N-SP80MS1 supports specified pickup and group pickup.

Specified pickup can answer specified user's incoming calls. When the user of specified pickup number is off or busy, you can press the pickup key to answer incoming call.

Group pickup can answer group's user incoming calls. When anyone in group receives an incoming call, you can press the group pickup key to answer.

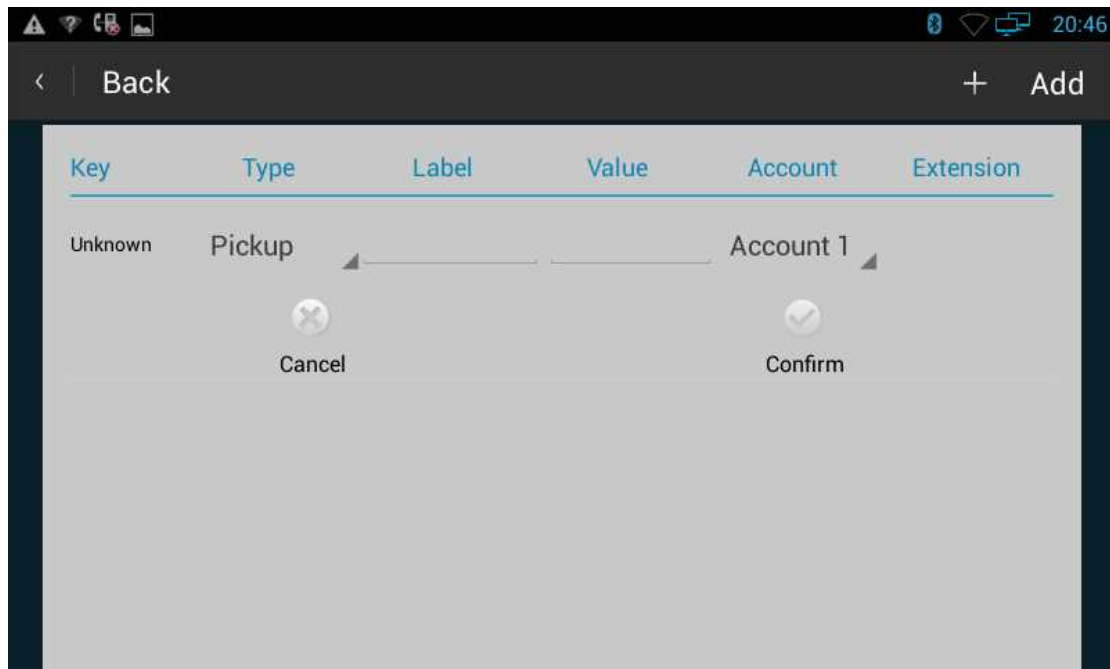

Note: Press the group pickup only to answer line 1 incoming call if there are many lines incoming calls in group.

5.8 ACD

Automatic Call Distribution (ACD) enables organizations to manage a large number of phone calls on an individual basis. ACD enables the use of SIP Multimedia Stations in a call-center role by automatically distributing incoming calls to available users, or agents. ACD depends on support from a SIP server. ACD is disabled on the phone by default. You need to enable it on a per-line basis before logging into the ACD system.

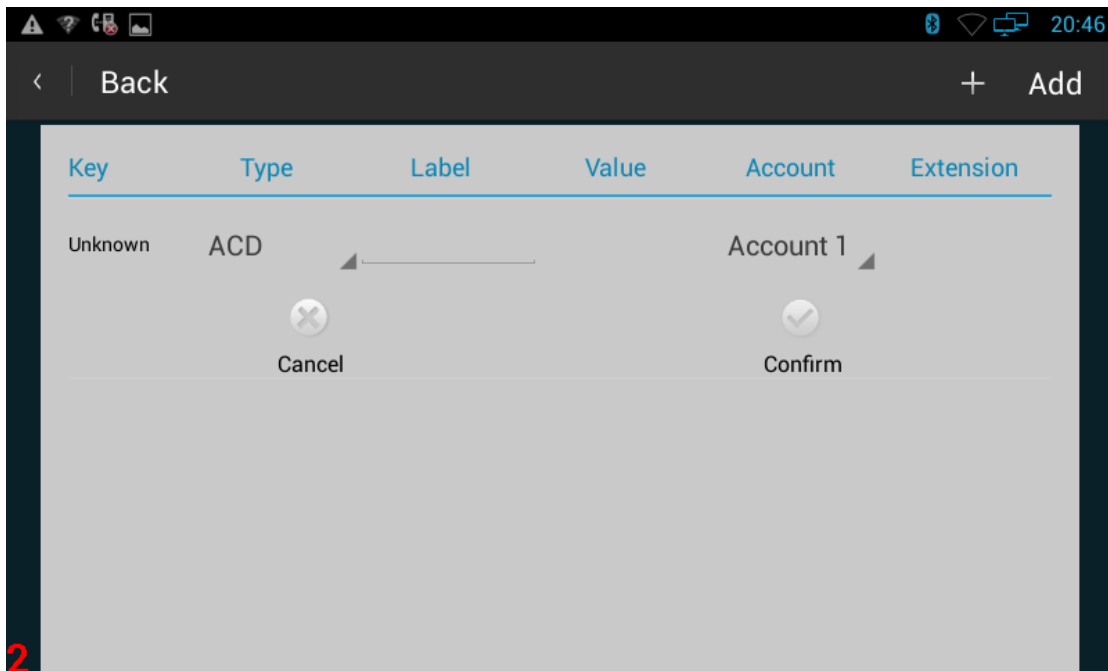

5.9 Hot Desking

In some working place, the people are always walking around. HotDesking feature will make the staffs login his account on any computer in the company. In some public places, the working people is not fixed, anyone can use HotDesking for logging his account, and setting the phones to the familiar mode, such as the remote function of the computer.

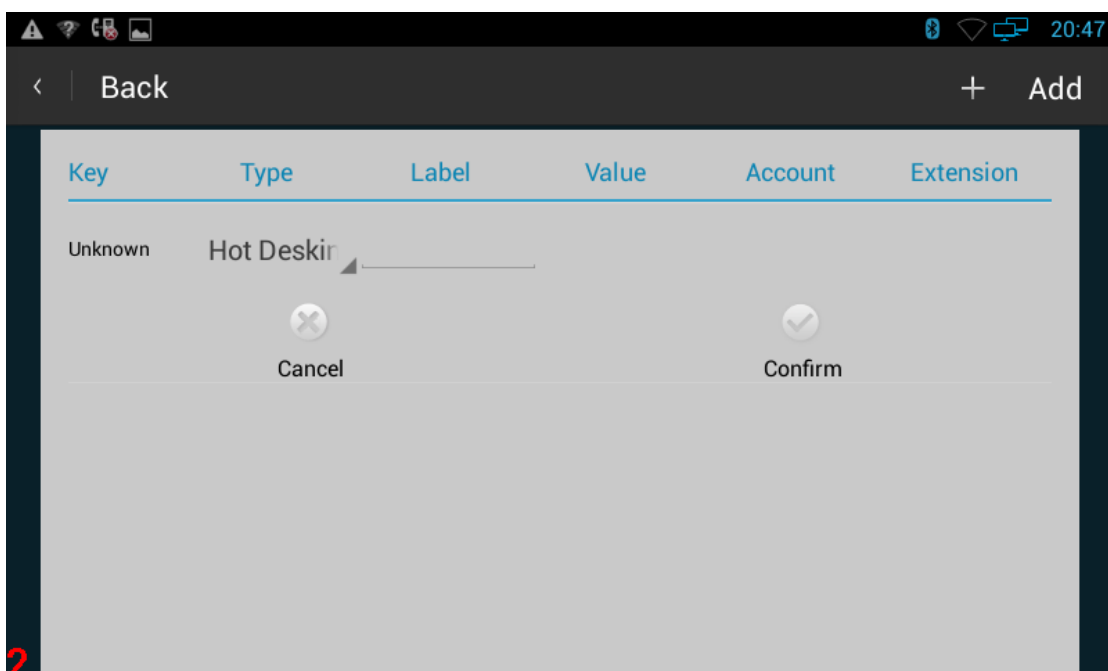

5.10 Conference

You can use the conference feature to hold a 3-way conference by pressing the Conference soft key to invite the current talking and one line talking held to attend conference.

5.10.1 Create 3-way conference

1. Create talking with first party;
2. Press  to create a new talking;
3. Input the number of second party and press the Video Call or Audio Call to make a call;

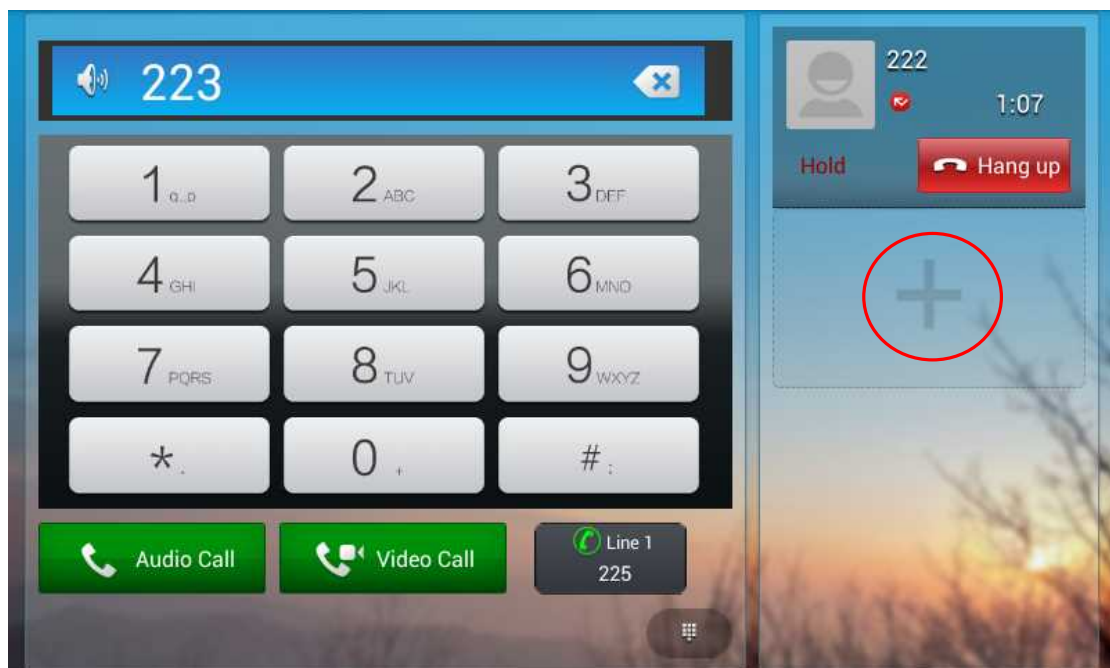

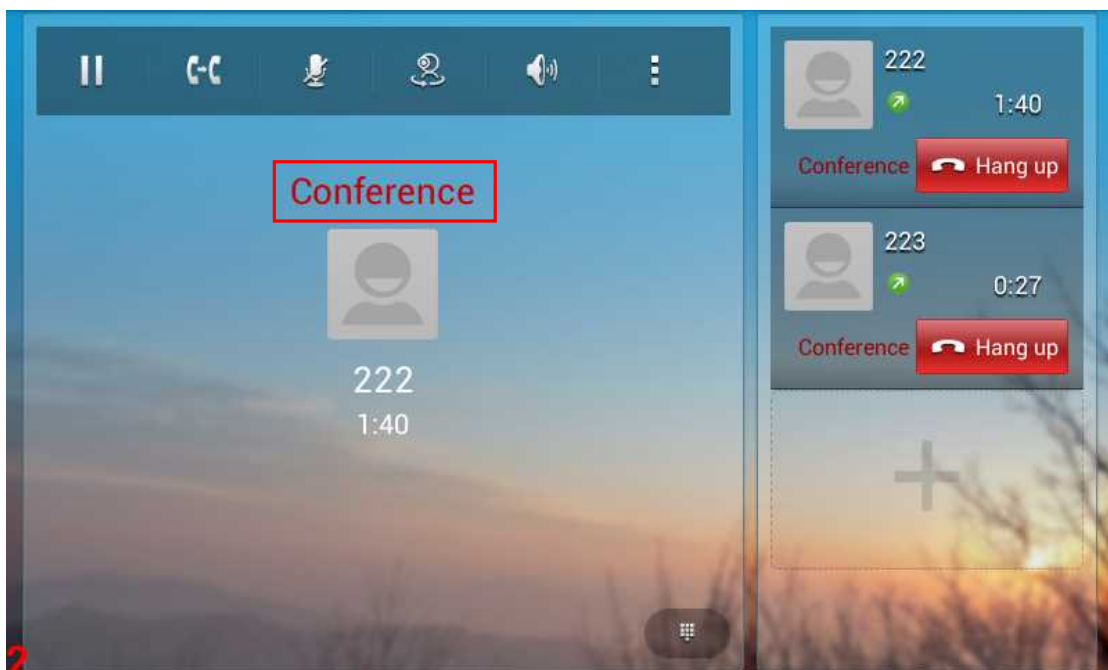
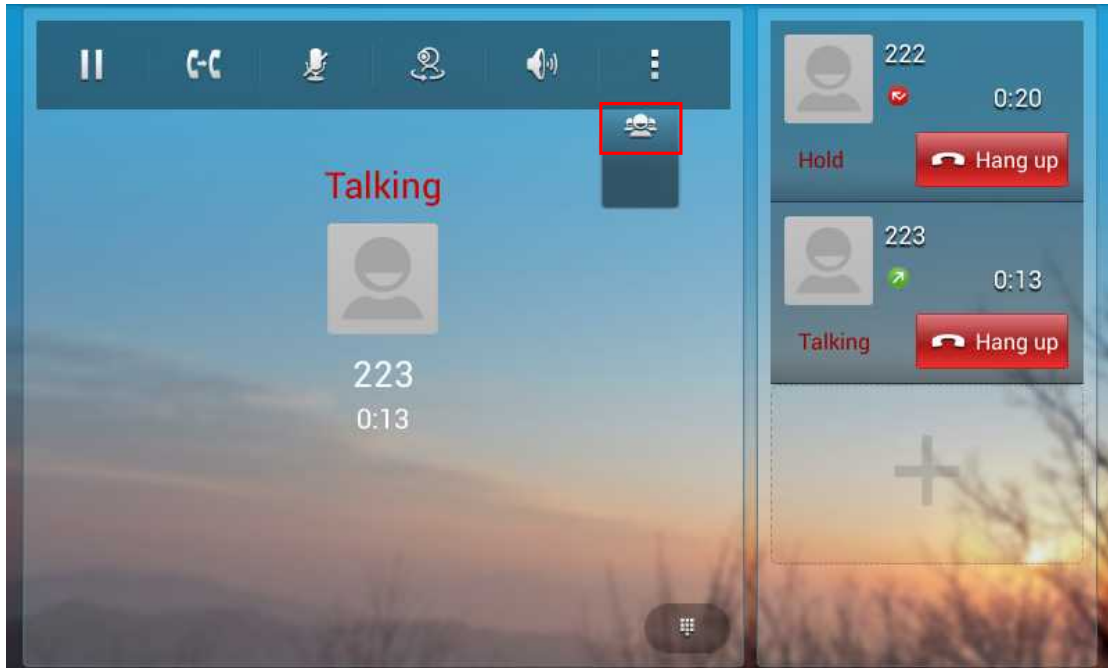

4. When the second party answers your call, press the Conference softkey or the Conference key on the keypad to start 3-way conference.





5.11 Transfer

5.11.1 Blind Transfer

1. When the SIP Multimedia Station blind transfers a call.

2. Pick up a call, press transfer key on the keypad or click .
3. Drag down the current call into the gray box
4. Press  to enter the target number, then click Confirm.
5. Click Blind to transfer the number.

5.11.2 Attended Transfer

1. Pick up a call, press transfer key on the keypad or click .
2. Drag down the current call into the gray box
3. Press  to enter the target number, then click Confirm.
4. Click Attended to transfer the number.

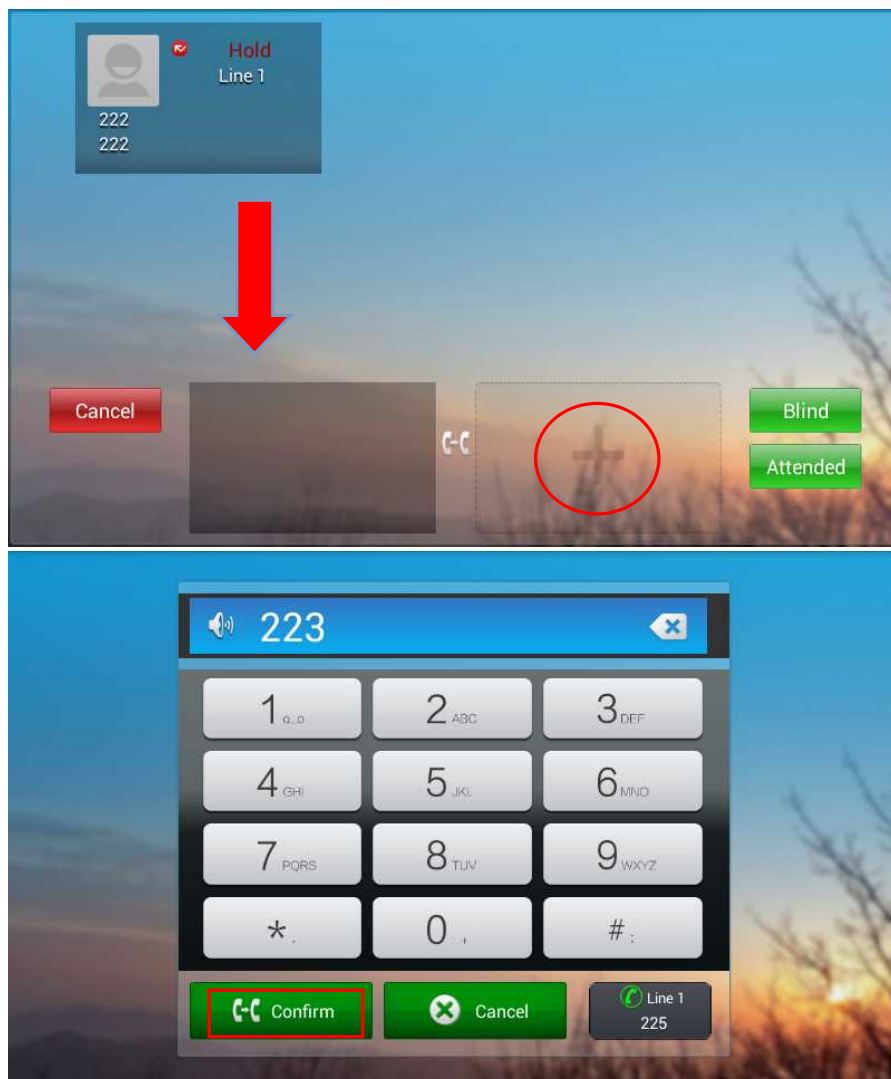

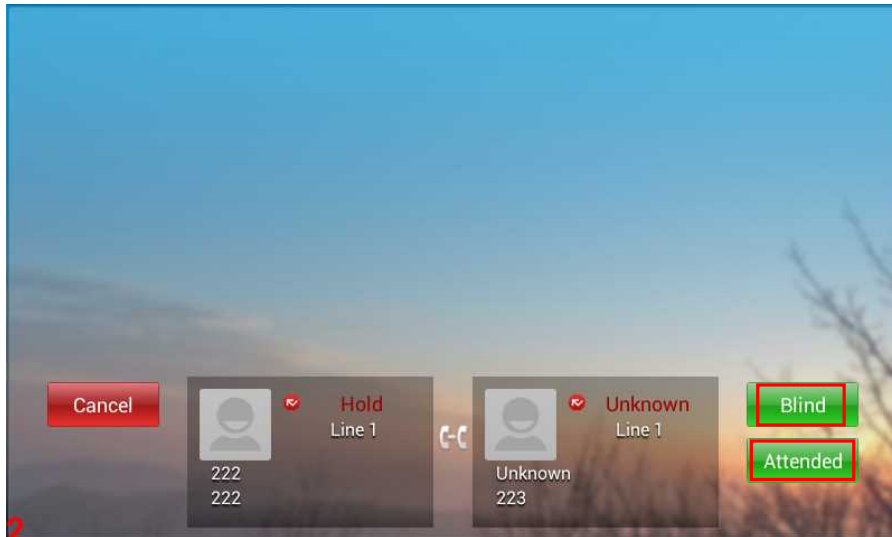



5.12 Keypad Input

Only numbers, and # can be input by keypad. The default Input method is Android keyboard. You can also download your preferred input method from the internet.

5.13 Webpage Browser

This section describes the default web browser in the video phone, and you can also download your preferred browser through the internet.

You can use one of the following methods to run the browser:

- Mode 1: In the main screen, click  ;
- Mode 2: In the main screen, click  -> .

5.13.1 Open The Webpage



5.13.1.1 Browser Address Bar

Run the browser, enter the URL in the address bar or direct input the information to search. After the input, you can click “Go” on the soft keyboard to complete.

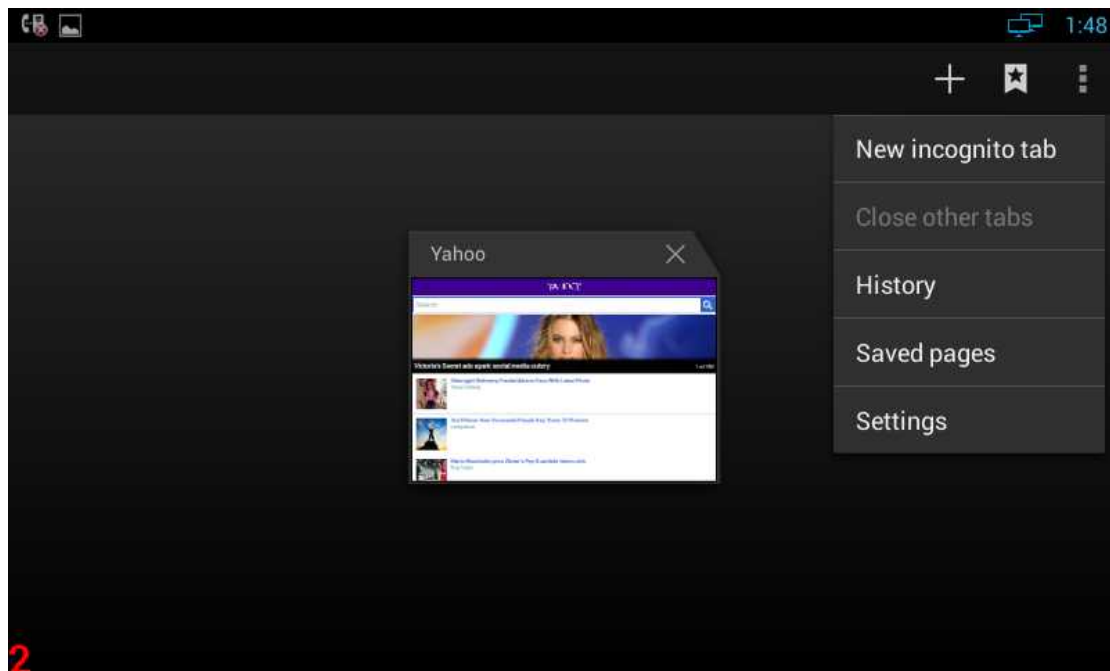

5.13.1.2 Bookmark And Browsing History

Run the browser, click  to view the “bookmark”:



	Add a new webpage
	View the bookmark and browsing history
	Others

5.14 Camera

Open the camera: in the main screen, click  -> .



You can view your photos and videos in “Gallery”

5.14.1 Photograph Mode

Turn on the camera, and the default mode is photograph mode.



5.14.1.1 Basic Setting

Click on the upper right corner  or long press on the screen to pop up the menu

	Setting
	White balance setting

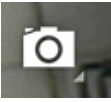
5.14.1.2 Mode Switch

Click on the lower right corner  to switch the mode.



	Panoramic camera mode
	Video mode
	Photo mode

5.14.1.3 Take A Photograph

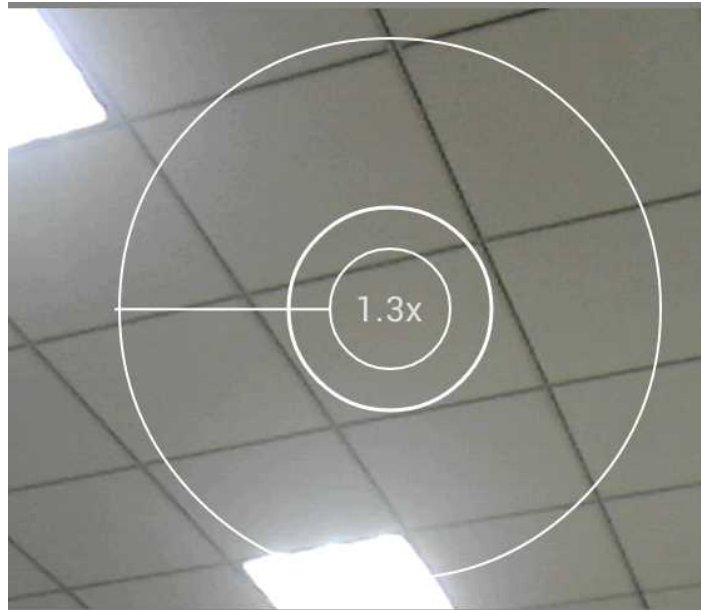
You can click on the center button  on the right side to take pictures. It supports automatic focusing, if you want to adjust the focal length, please use two fingers to press on the screen, shrinkage or expansion to adjust the focal length.



5.14.1.4 Take A Video

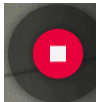
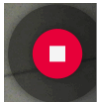

Click  ->  to switch to video mode.

Click , video starts when the icon turns to . And click  to stop the video recording and save.

5.15 Gallery

You can use Gallery to view photos or videos, and you can also view the picture or video downloaded from the Internet. You can edit the photo or picture and set it as wallpaper.

You can follow the below method to enter into the gallery:

In the main screen, click  -> 

5.15.1 View Photo & Picture & Video

Enter the gallery, and you can view all photos, pictures in the device, as shown below:

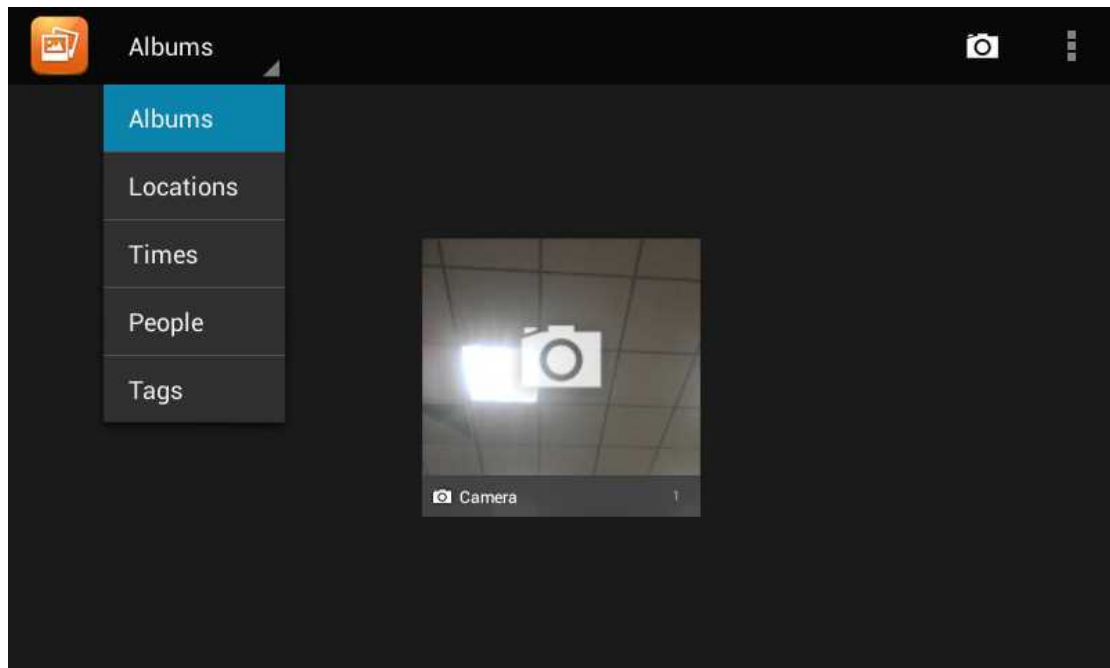



Click the icon on the upper left corner, and you can view photos and videos in groups in the drop-down list. Click on the folder to view all the photos.

While viewing photos, you can use two fingers to press on the screen, shrinkage or expansion to shrink or enlarge the image.

5.16 Bluetooth

Bluetooth is a proprietary, open wireless technology standard for exchanging data over short distances from fixed and mobile devices, creating personal area networks with high levels of security. On N-SP80MS1, users could use Bluetooth to transfer files, share contact information with other Bluetooth portable devices by installing Bluetooth Application, or use Bluetooth headset for making calls.

To connect to a Bluetooth device, turn on N-SP80MS1's Bluetooth radio first. The first time when using a new Bluetooth device with the N-SP80MS1, "pair" the device with N-SP80MS1 so that both devices know how to connect securely to each other. After that, users could simply connect to a paired device. Turn off Bluetooth if it's not used. Bluetooth related settings are under N-SP80MS1's Settings application → Wireless & networks. Users could access it via the following two ways:

- In the main Screen, press  button -> System Settings -> Wireless & Networks;
- Press on screen  and click on  -> Wireless & Networks.

5.16.1 Turning Bluetooth On /Off

- Go to N-SP80MS1's Settings;
- Click on Wireless & Networks;
- Click or untick the option for Bluetooth.

5.16.2 Changing Bluetooth Device Name

The N-SP80MS1 uses "SVP3300" as Bluetooth device name by default. The device name will be visible to other devices when connecting them. Follow the steps below to change the name:

- Go to N-SP80MS1's Settings;
- Click on Wireless & Networks;
- Click on Bluetooth, and click Bluetooth to turn it on;
- Click on Bluetooth settings → Rename, and enter a new name. Once done, click "OK".

5.16.3 Pairing N-SP80MS1 With A Bluetooth Device

Before connecting N-SP80MS1 with other Bluetooth device, users must pair them first. They will stay paired afterwards unless they are unpaired.

- Go to N-SP80MS1's Settings;
- Click on Wireless & Networks;
- Click on Bluetooth, and tick Bluetooth to turn it on;
- Click on SEARCH FOR DEVICE;

- The N-SP80MS1 scans and displays the IDs of all available Bluetooth devices in range. If the device you would like to pair with does not show up in the list, ensure that the other device is turned on and set to be discoverable;
- If the N-SP80MS1 stops scanning before the other device is ready, touch SEARCH FOR DEVICE;
- The discovered device will show in the available devices list with device ID. If it's unpaired, it will show "Pairing" under the device ID. Make sure the Bluetooth device is active in pairing mode. Then tap on the device ID on the N-SP80MS1 to pair them. Confirm the passkey in the prompted message (if any). Or if PIN is required, please refer to the device's documentation or other procedures to obtain the PIN.

5.16.4 Un-pairing A Bluetooth Device

After successfully paired, the N-SP80MS1 will show item "PAIRED DEVICES" above the Bluetooth device ID in the scan list.

Once it's connected, users could also tap on to the Bluetooth device ID needed to be unpaired, then tap on Unpair in the prompted message.

5.17 USB

The video phone supports USB connection for keyboard and USB storage devices. To use USB keyboard, simply plug it into the USB port on the right side of the video phone and it will be ready to use.

To connect and access USB storage device:

- Insert USB storage device into USB port at the right side of video phone;
- It will take a few seconds for the video phone to prepare the connection;
- To access USB storage, click on the screen  -> Explorer -> USB, to access and manage your data.

5.18 Calendar

To start the calendar:

- In the main screen, click  -> Calendar;

As shown below:

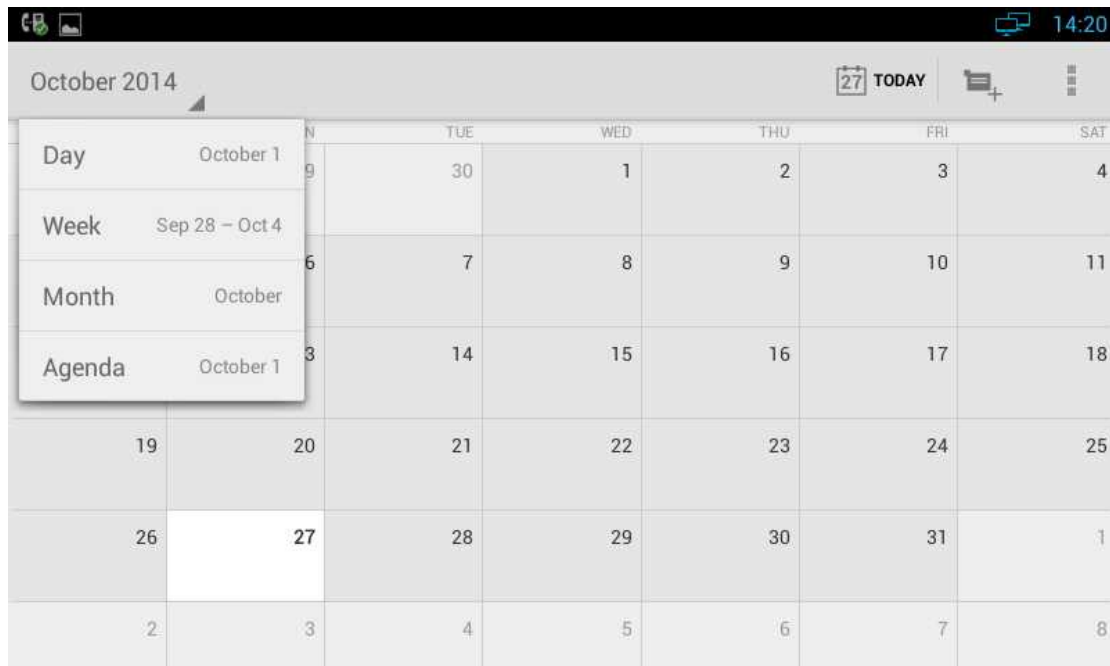

If one day has activity, color will appear on the calendar to remind.

5.18.1 Add An Account

While using the calendar at the first time, it will remind you to add an account.

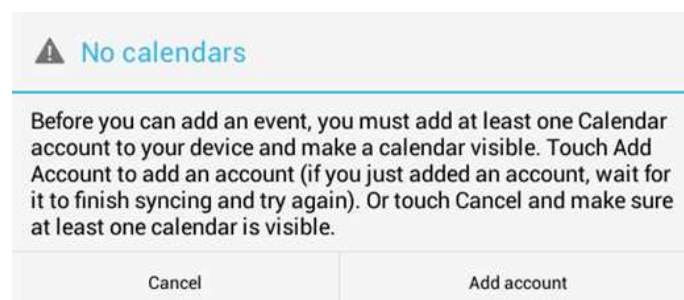

Click "Add account" to add an account, and then synchronize all the schedules of the account to the calendar.

5.18.2 View Calendar

The calendar will display weekly by default, and you can slide the calendar up and down to view the different weeks. In order to view the activities or create the new activities, you can also make the calendar display daily or monthly. While using daily or monthly displaying, you can slide the calendar left and right to view the different day or month.

Click the date on the upper left corner, it will display the drop-down list

Day	October 1
Week	Sep 28 – Oct 4
Month	October
Agenda	October 1

, Calendar displaying mode can be selected as daily, weekly or monthly.

5.18.3 New Activities

1) While Calendar is displaying as daily or weekly, you can use the following methods to create a the new activity:

- Click on the date, and then click on the time period;

- Click on  ;

2) Input the details of the activity, as shown below:

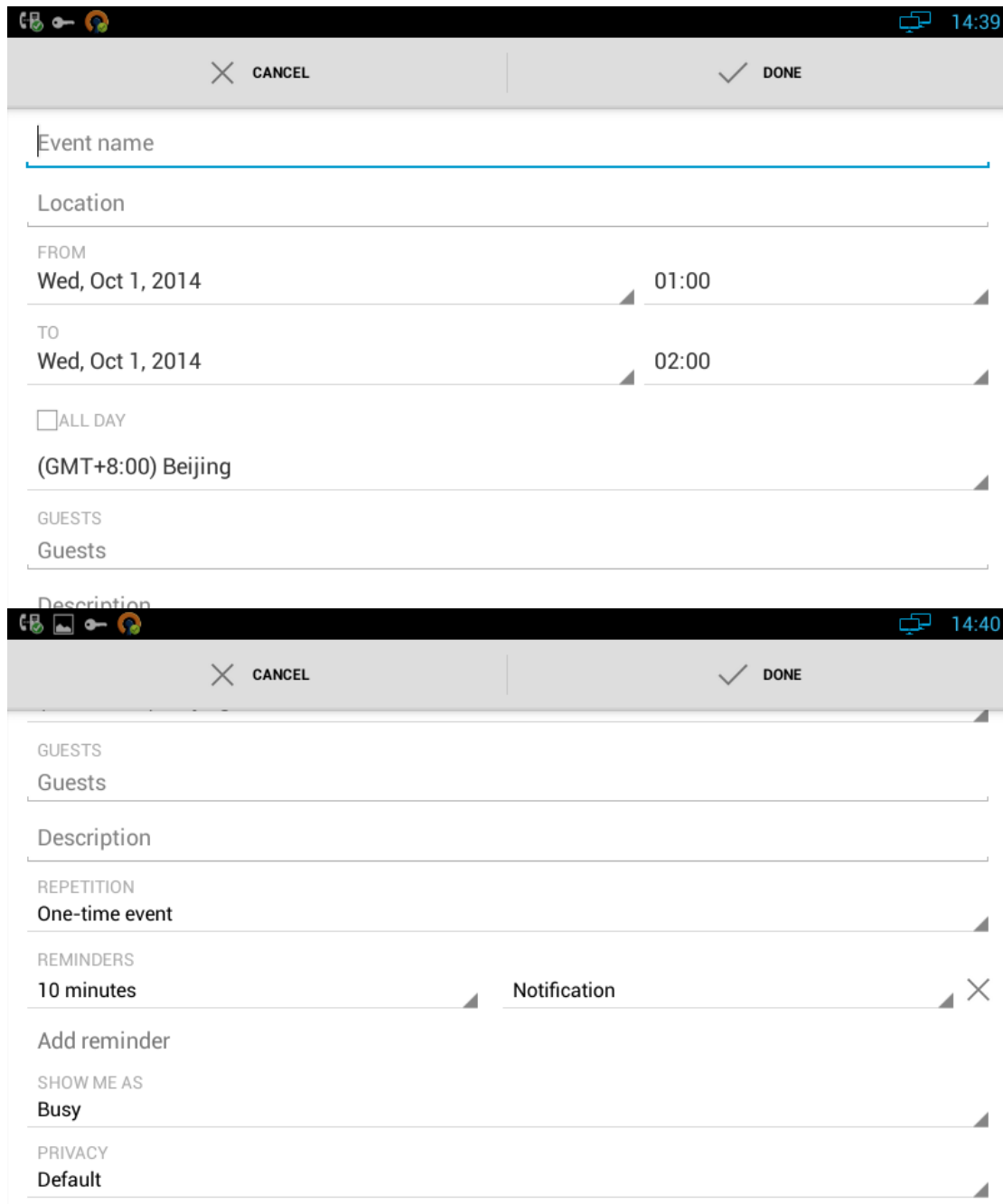

3) Click “Done” to finish.

5.18.4 Edit Activities

You can click on schedule needed to be modified to edit the schedule.

5.18.5 Delete Activities

While viewing the activity, you can click “DELETE” on the upper right corner to delete

the activity.

5.19 Clock



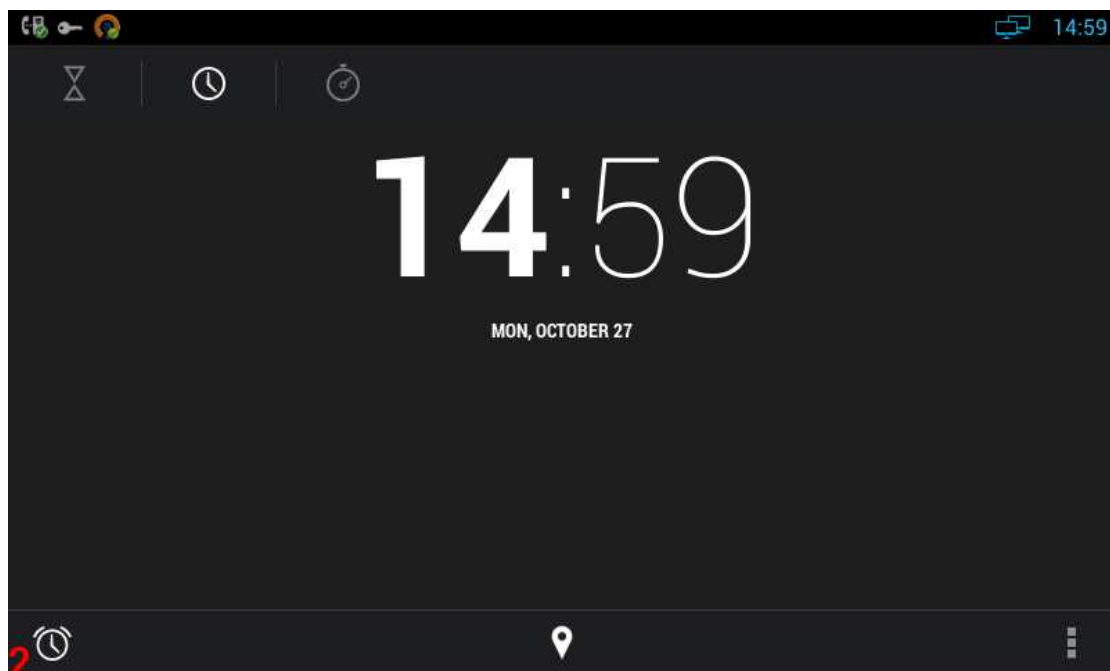

Enter the Clock:

- In the main screen, click  -> Clock;

As shown below:



Description:

	Alarm
	Countdown timer
	Stopwatch
	Time zone
	Others

5.19.1 Alarm

You can add one or multiple alarms:

1) Click ;

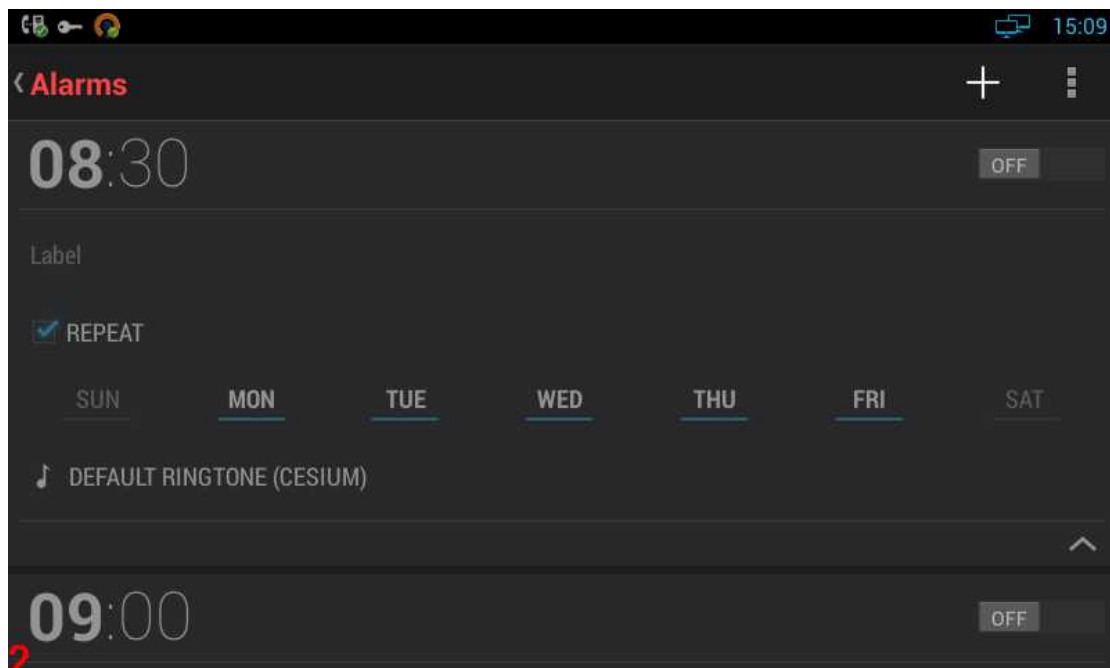

2) Click ;

3) Input the time of alarm;

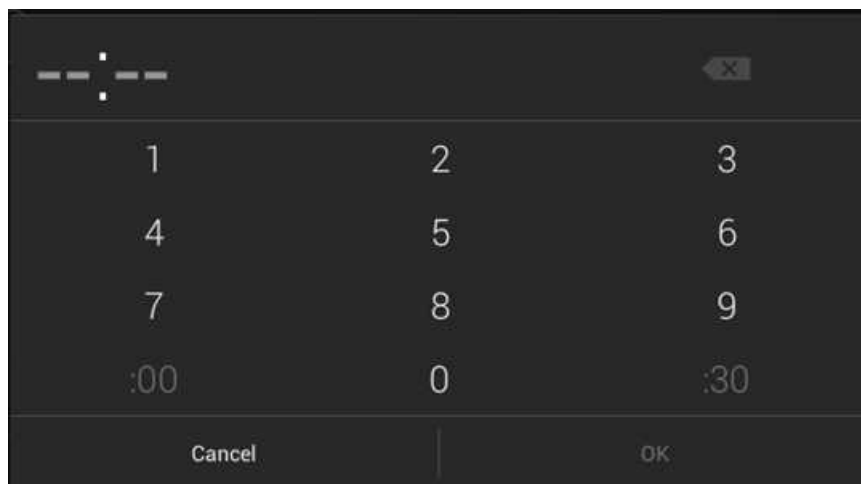

4) If you want to repeat the alarm in some days of a week, please click “REPEAT”;

5) You can choose the ringtone of the alarm.

5.19.1.1 Enable/Disable Alarm

You can click ON/OFF to enable or disable the alarm.

Note: If power off the phone, the alarm will also be off.

5.19.1.2 Modify Alarm

If you want to modify the status of the alarm, including time, repeat data, alarm ringtone, you can directly click on the alarm.

5.19.1.3 Delete Alarm

In Alarm page, you can use the following method to delete the alarm:



- Press and hold the alarm, after pop-up the dialog box, click  , and then click "OK".

5.19.2 Countdown Timer

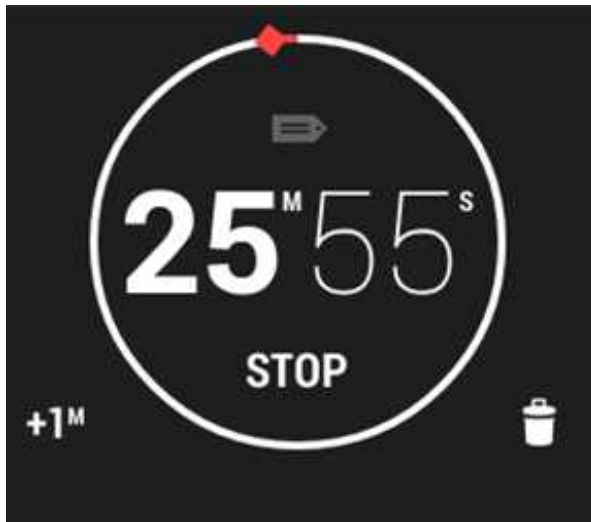
- 1) Click 
- 2) Click the number to set the countdown time
- 3) Click "START"



Click on the time in the page of countdown timer can stop or continue the time, and the other buttons are described as followed:

	Add one minute to countdown timer
	Delete the current countdown timer

5.19.3 Stopwatch

- 1) Click ;
- 2) Click "START" or "STOP" to start or stop the stopwatch;
- 3) Click the time icon to start a new time;
- 4) When the time is on hold, click to reset the timer.

5.20 Email

Email Application can let you use POP3 or IMAP service to send and receive e-mail.

Start Email:

- In the main screen, click  ->Email

5.20.1 Add A New Email Account

Make sure the email account has enabled POP3 or IMAP service, and you can add many accounts.

- 1) Please choose one of the following methods to start:
 - If you haven't added an e-mail account yet, while starting the e-mail application, you will be asked to set up your account, as shown below

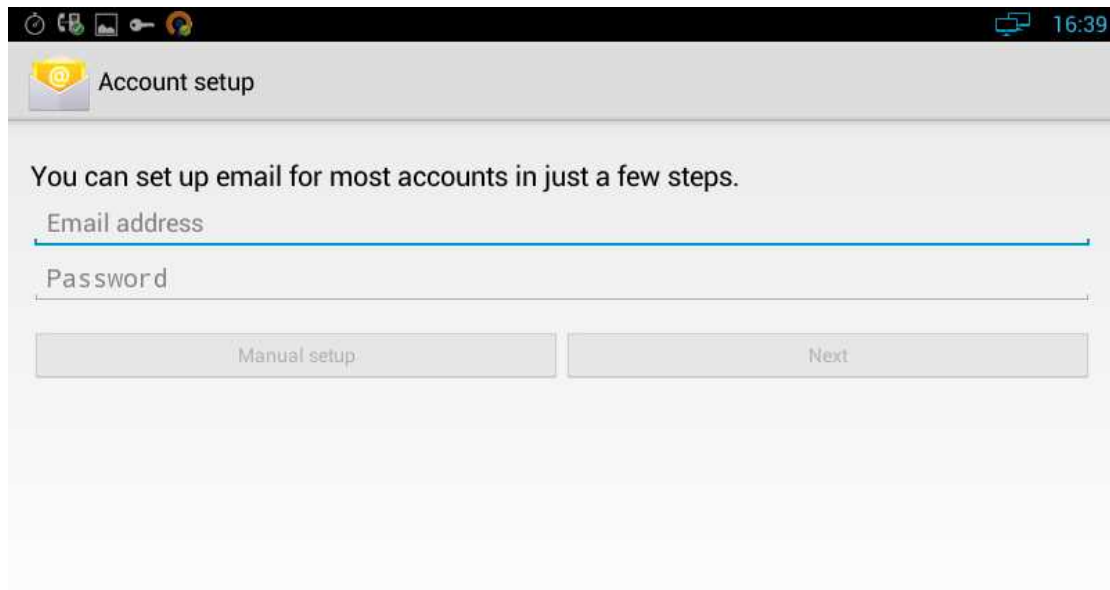

- If you have already set up an email account, In the main Email page, Press “Menu” button, and then click “Account”, and last press “Menu” to “Add Account”.

2) Input the email account and password, and then click “Next”;

If there is no account type in the equipment database you want to set, the device will require you to enter more detailed information (the receiving server settings and outgoing server settings).

3) Input the account name and your name, click OK.

5.21 Music

In the main screen, click  ->Music.

The music page is shown as below:

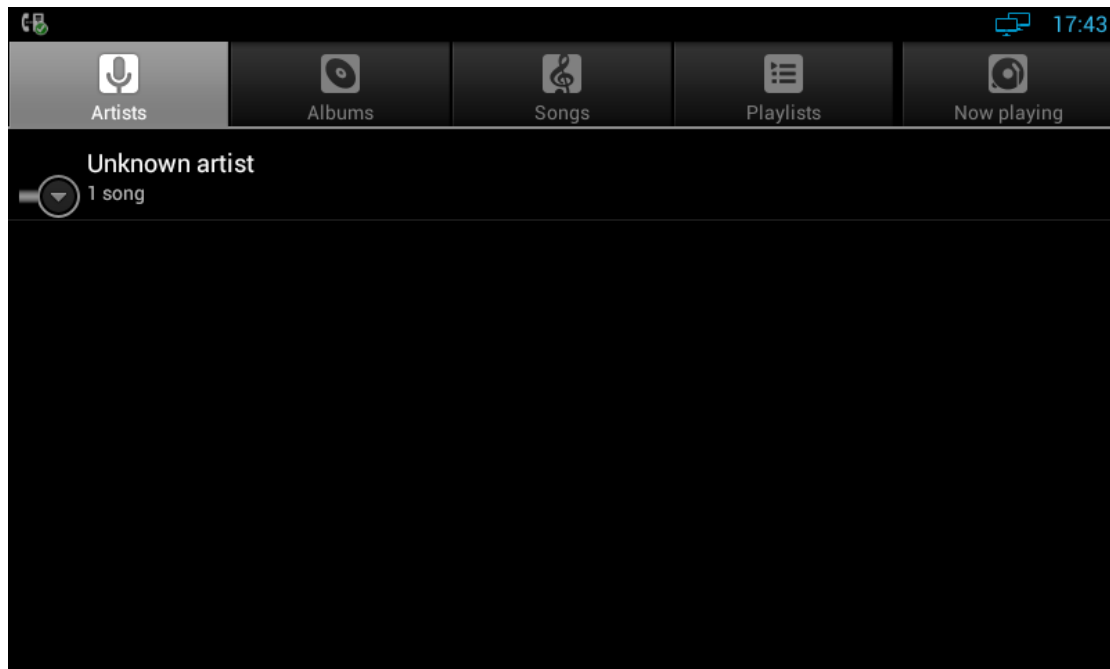

You can click the labels of Artists, Albums or Songs to view all songs. You can also view or play the songs from the playlists.

To view the currently playing song, please click the "now playing" label.

5.22 Explorer

You can use explorer to manage the files in the device.

In the main screen, click  -> Explorer, as shown below:

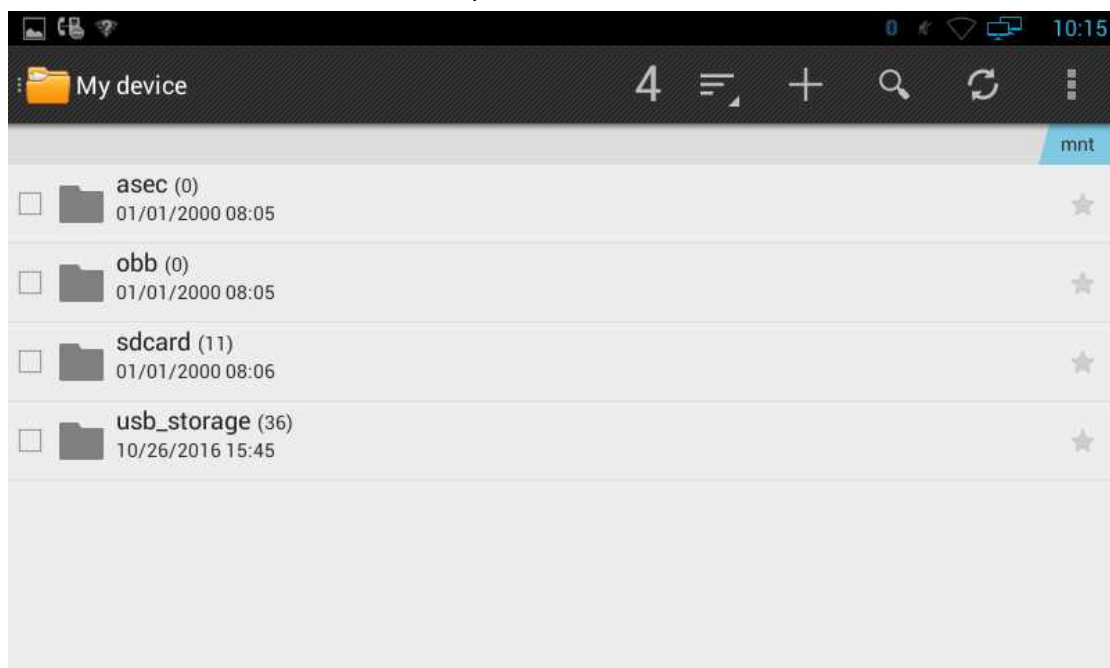



5.23 Video Player

You can use video player to play local videos.

To run the video player: In the main screen, click  -> Video

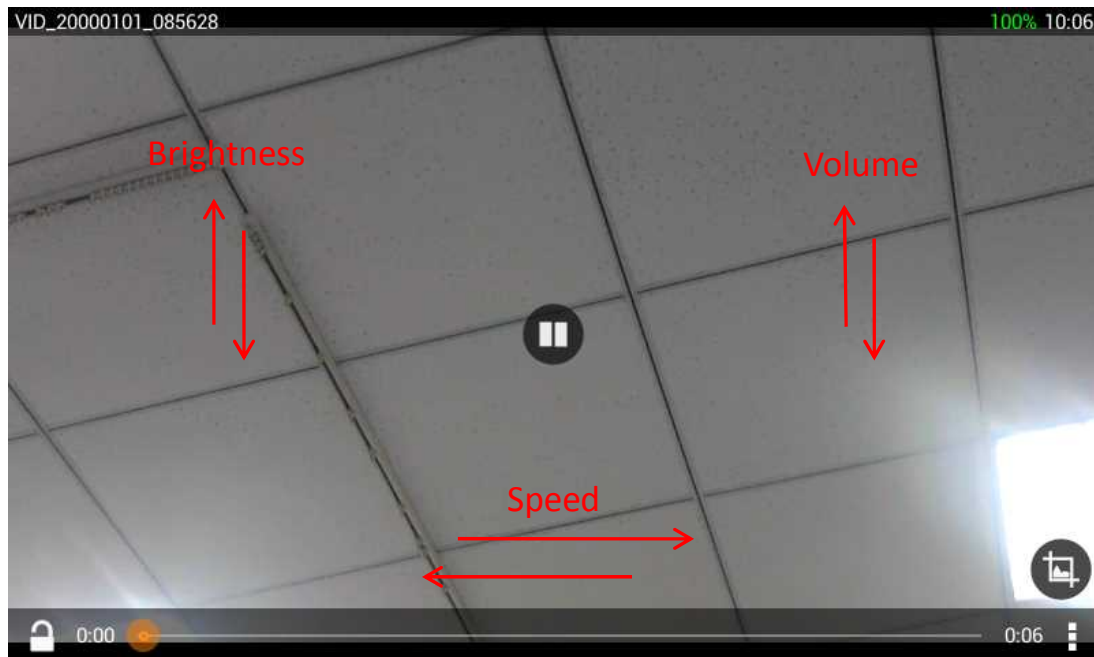
After entering, you can click on the list of videos to watch. As shown below:



- Follow the prompt as shown in the picture, slide different direction to adjust the brightness ,volume or speed.
- Click  to choose different screen size.
- Click  to adjust playback speed or add suitable file to play. As shown below.

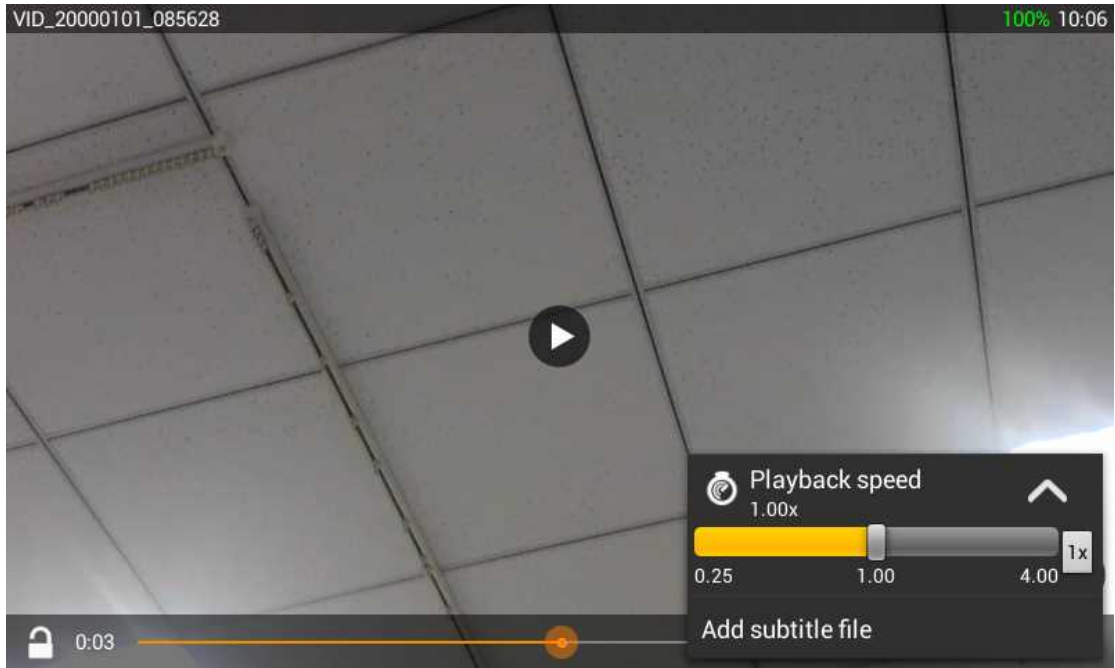

5.24 Others

5.24.1 Apk Installer

User need open phone permission before installing. Go to the path: Settings->Security, tick Unknown sources.

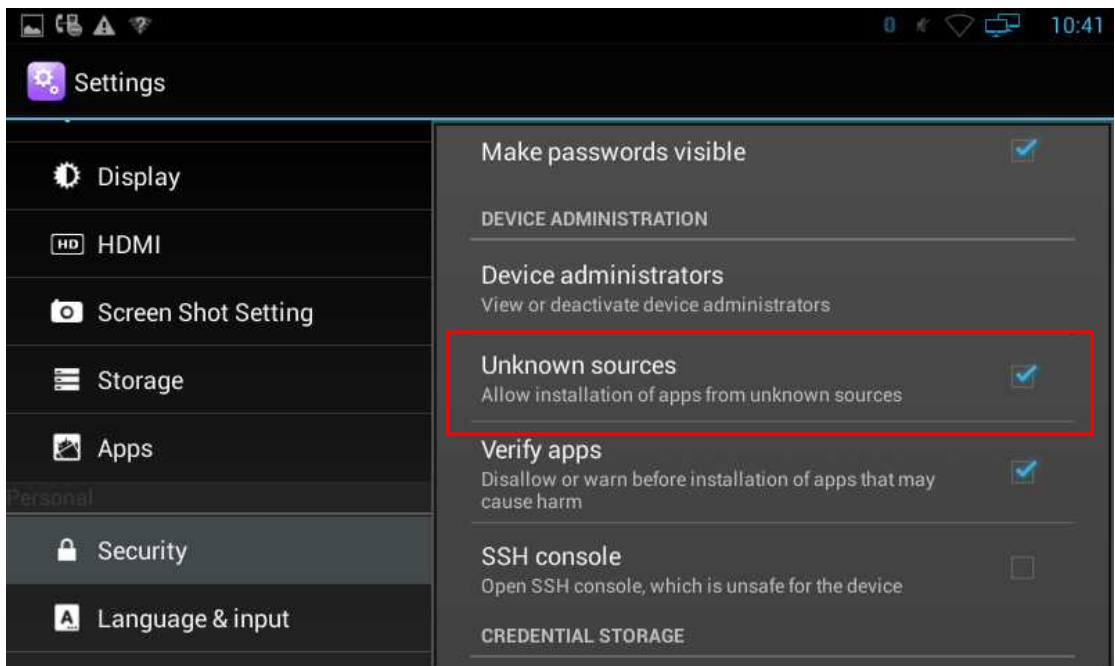

In the main screen, click  ->Explorer. Select the Apk you want to install, follow the prompt to operate.

5.24.2 Ping Tool

You can use the Ping tool for Ping query, network packet capture and view the log information.

5.24.2.1 Ping Query

Ping query interface is as shown:

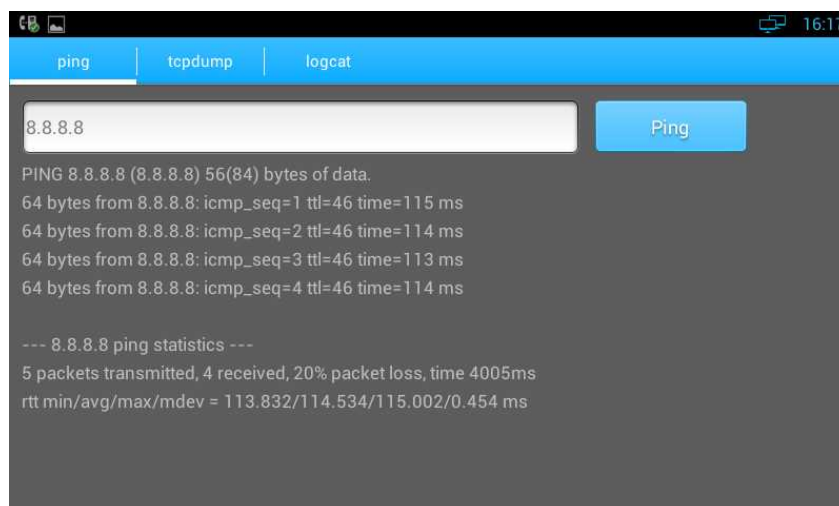

You can input the address you want to Ping, click the Ping button, you can view the Ping query results. If you take a long Ping query, in the input box, please manually enter the Ping + address, such as: , and then click the Ping button.

5.24.2.2 Tcpdump

Log captured tool interface is as shown:

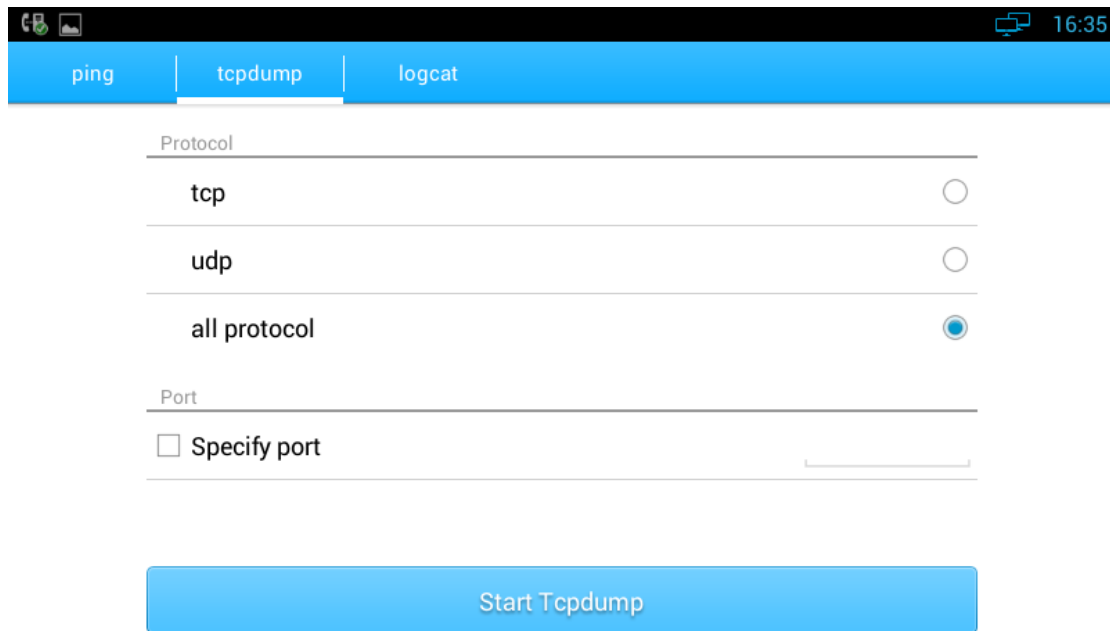



You can choose what type protocol and specified port you need to capture the logs. Press “Start Tcpdump” to start the log captured.

If you want to finish the log captured, you can press “Stop Tcpdump” to stop the capture, and the system will prompt the file saved path. You can use Wireshark and other tools on PC to read the logs.

5.24.2.3 Logcat

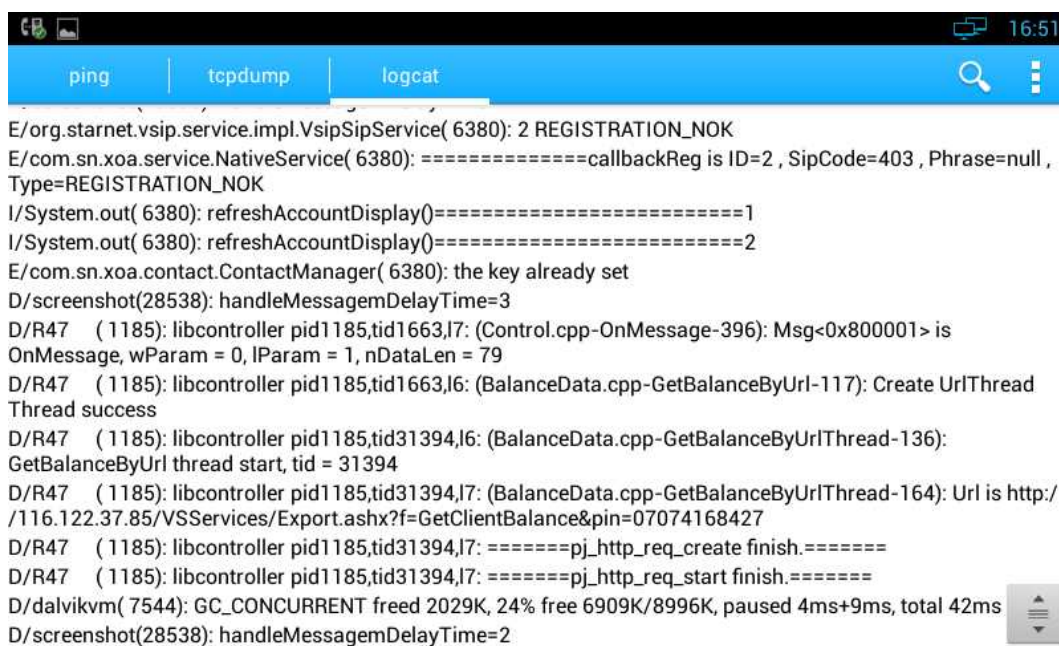
Logcat interface is as shown:



You can use  to search the log information, and select the log level through the drop-down list.

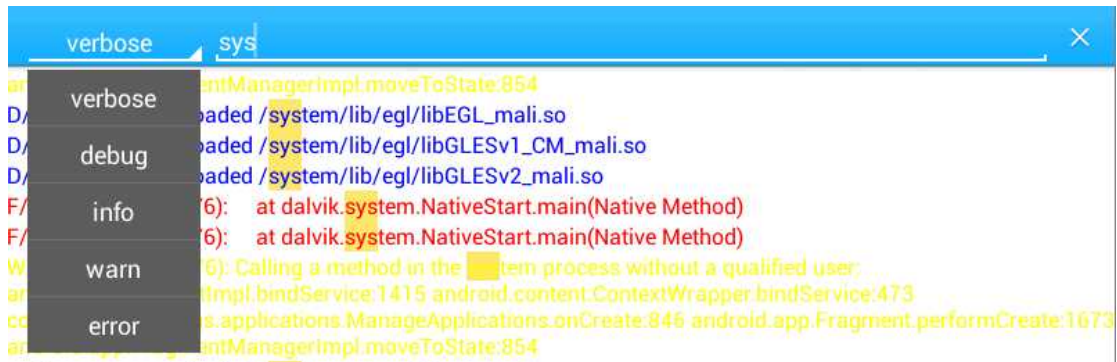

Or click  to see more options.

if you need to save the log, please click , select "Save"

If you need to highlight the log information, please click , select "highlight", and then the log will be showed as different color.

6 Software Upgrade

6.1 Immediate Update

Choose one way below to enter the system upgrade interface:

- In the main screen, press “Menu” on board -> System Settings -> System -> About Multimedia Terminal -> System Upgrade -> System Update Now
- In the main screen, tap on settings icon  -> System -> Multimedia Terminal -> System Upgrade -> System Update Now

Update interface as shown:

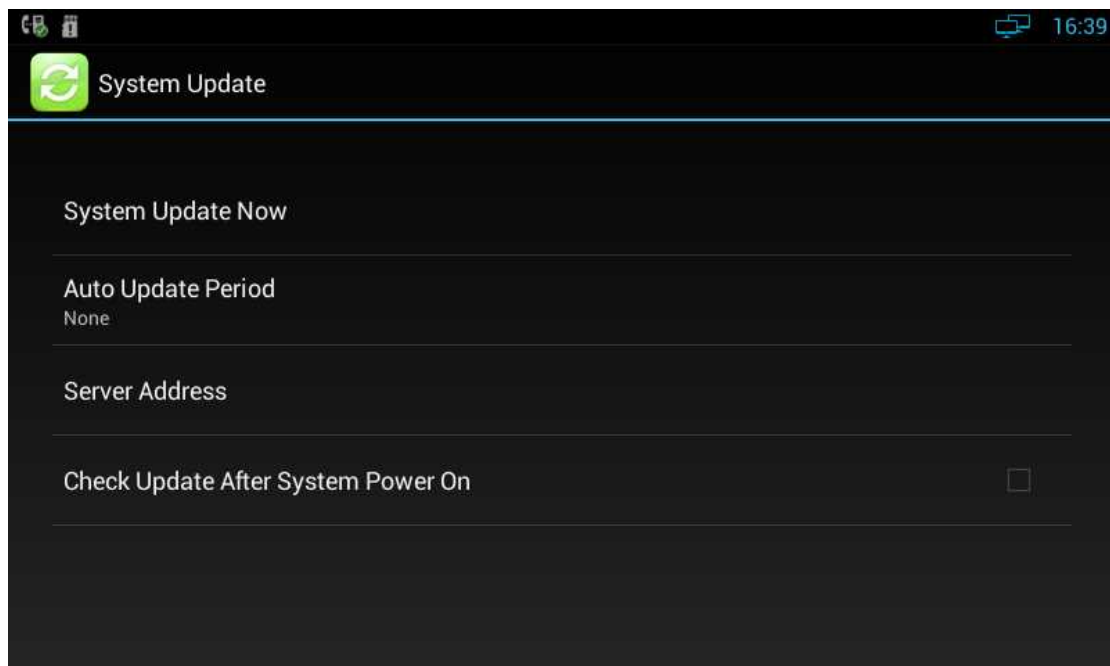

Three ways to update immediately: Select other upgrade package, Local Update, Remote Upgrade, as shown:

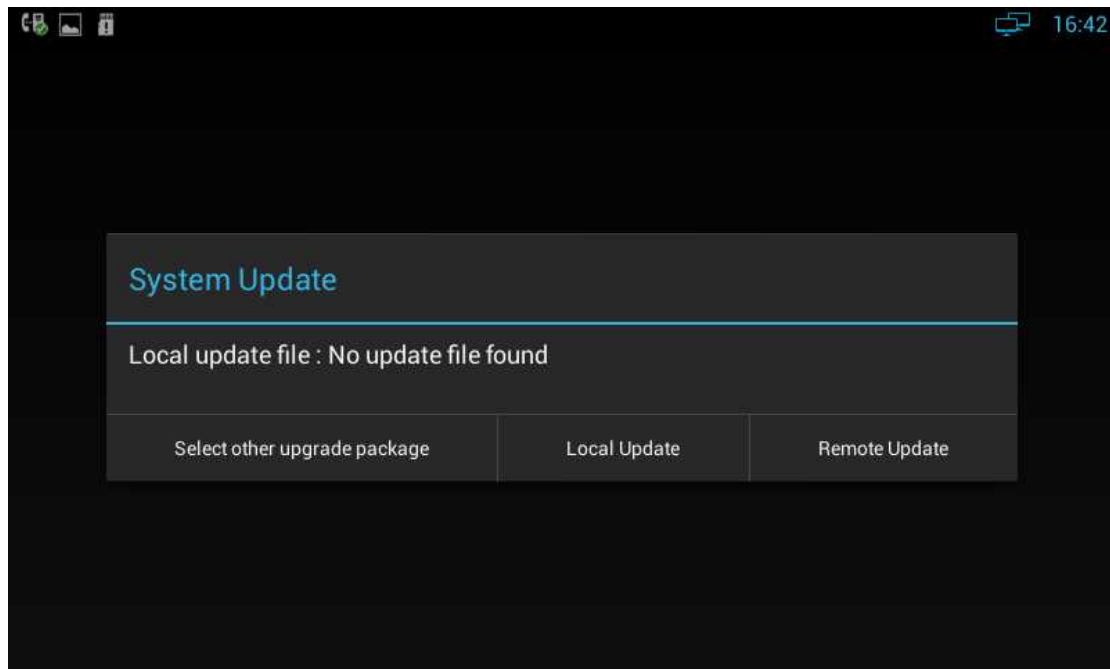

6.1.1 Select Other Upgrade Package

1) Via USB to Upgrade

Put upgrade package into USB, insert USB, then click “Select other upgrade package”, find “/mnt/usb_storage”, find the upgrade package, then click “OK” to upgrade.

2) Via Internal Memory to Upgrade

Use USB to copy the upgrade package into Internal Memory, then press “Select other upgrade package”, find “/mnt/sdcard”, find upgrade document, then click “OK” to upgrade.

6.1.2 Local Update

1) Via USB to Upgrade

Change the name of upgrade package into upgrade.zip, then copy it into USB, insert USB, enter the upgrade interface, you will find the path of upgrade package, because video phone has searched it automatically, click “Local Update” to start upgrading, as shown below:

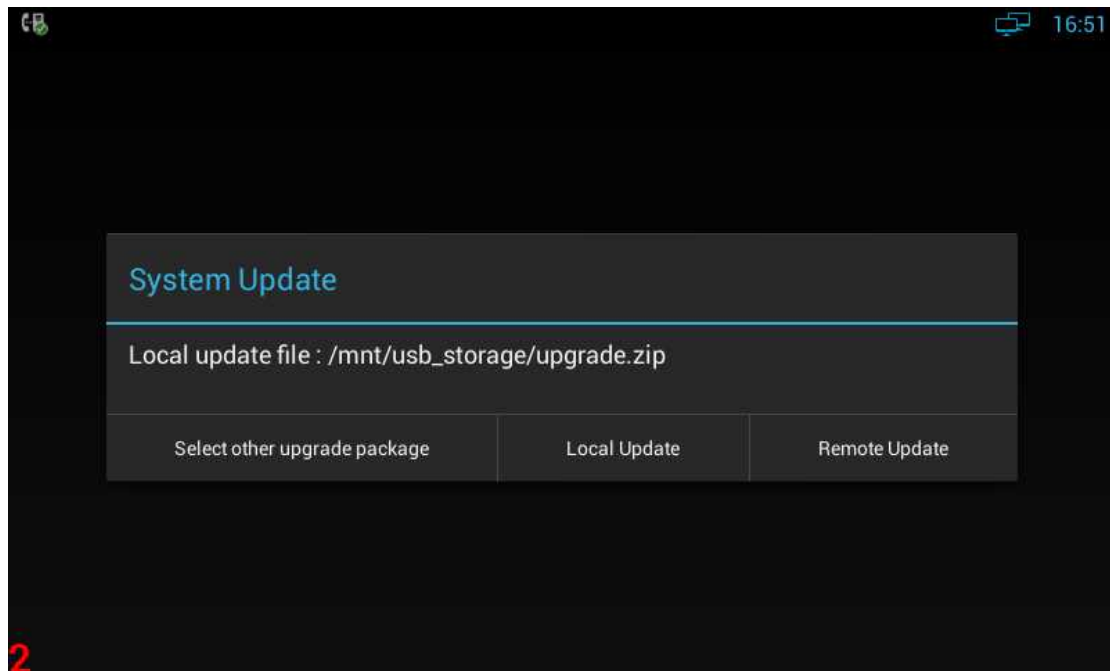

2) Via built-in SD Card to upgrade

First, change the name of upgrade package into upgrade.zip, then copy it into USB, and then use USB to copy the upgrade package into Internal Memory, enter the upgrade interface, you will find the path of upgrade package: /mnt/sdcard/upgrade.zip, because video phone has searched it automatically, press “Local Update” to start upgrading.

6.1.3 Remote Update

1) Enter the interface in figure 5-1, click “Server Address”, and input the server address that contains upgrade package. As shown below:

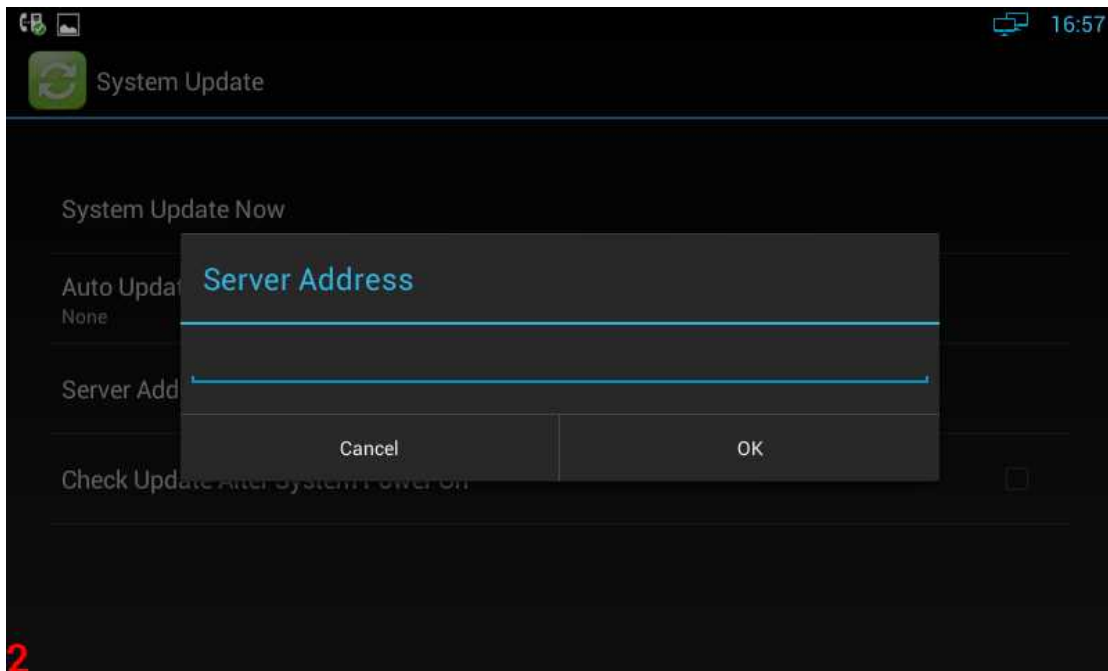

2) Click “Remote Upgrade”, video phone will check the new version automatically. If exist a new version, it will prompt. Press “OK” to download upgrade document.

3) After finish downloading, it prompts “Download update image success! You need to restart system for update! ”, press reboot now, and then system will upgrade automatically. As shown below:

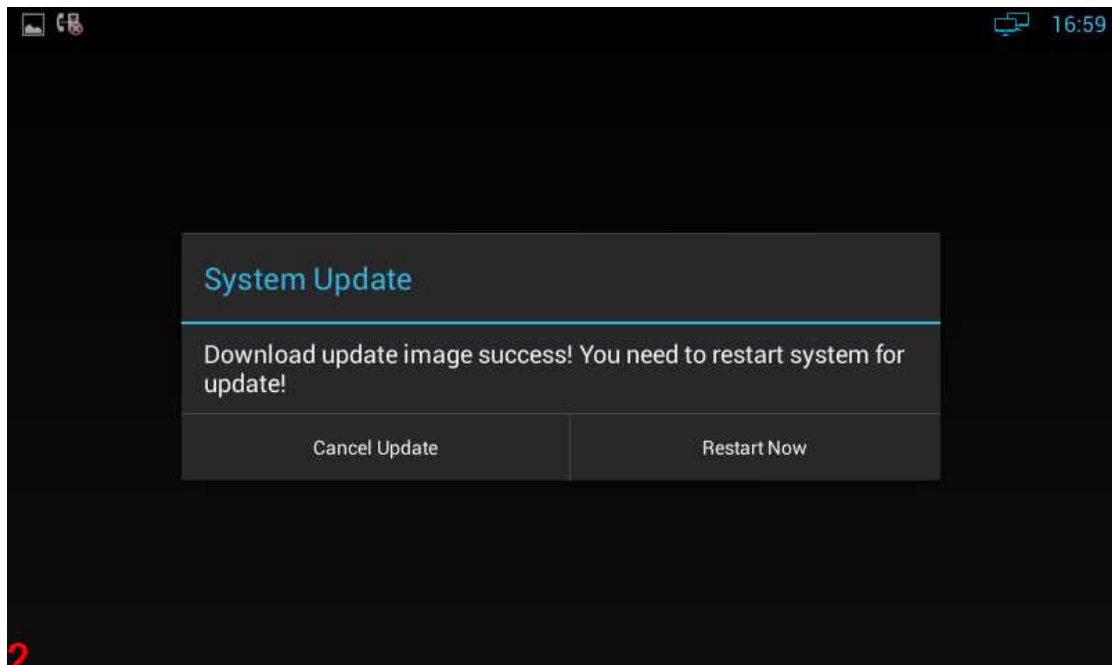

6.2 Auto Update Period

Auto Update Period includes four modes: None, One Day, One Week, and One Month. The terminal will detect the new version automatically in time, if there is, the status bar will show “There is a new version, please update!”. Click and download the image for upgrade.

As shown below:

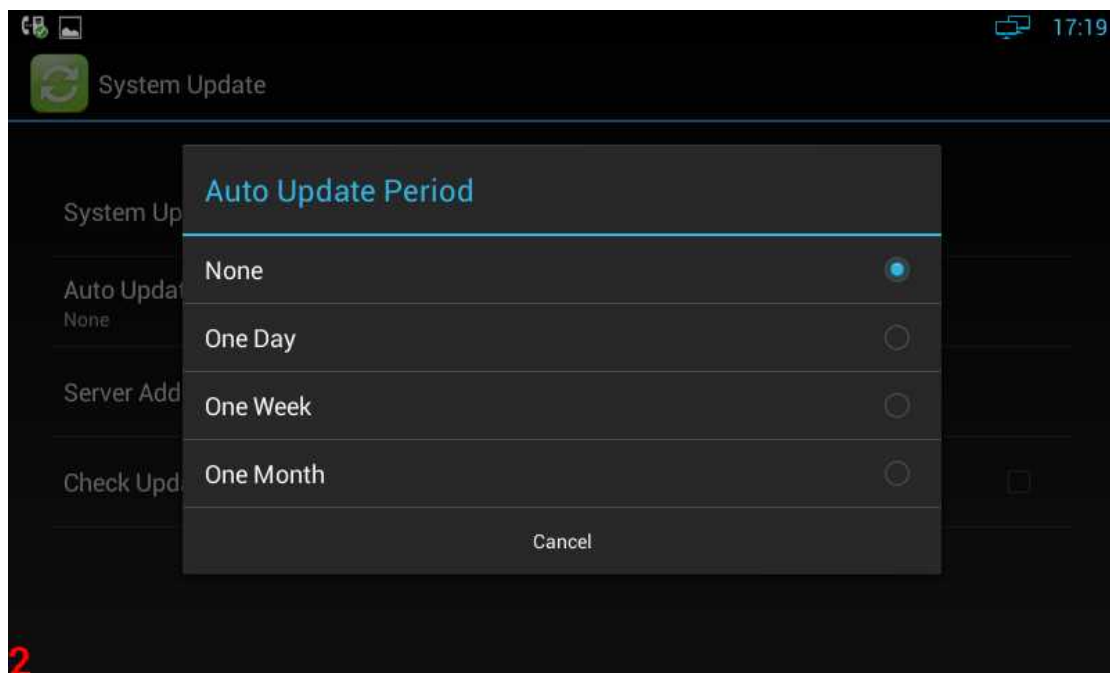

6.3 Upgrade on the web

1. Click Upgrade->Basic
2. Choose the software you want to update from the computer.
3. Click .

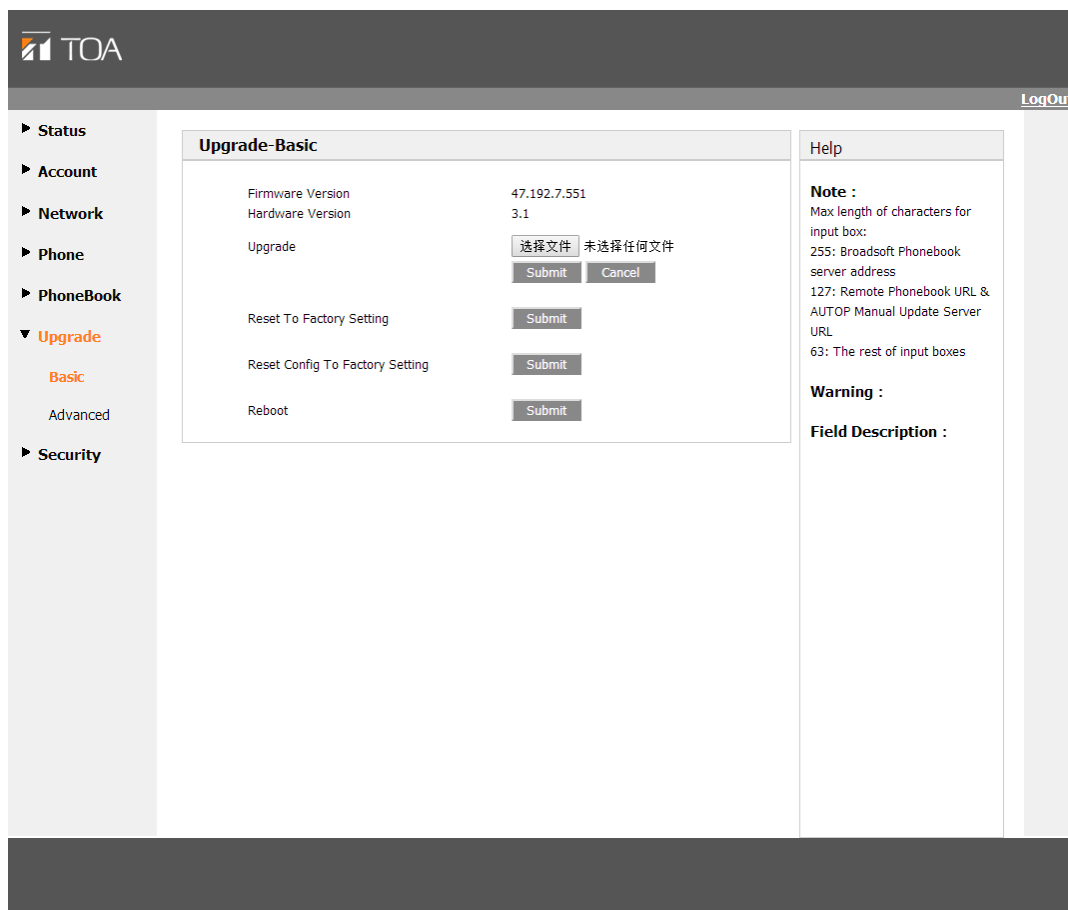

6.4 Check Update After System Power On

Click “Check Update After System Power On” in figure 5-1. Every time you power on, the system will check the new version automatically. If there is a new one, the status bar will notice: “System has new version, please update now!”, click and download the image for upgrade.

As shown:

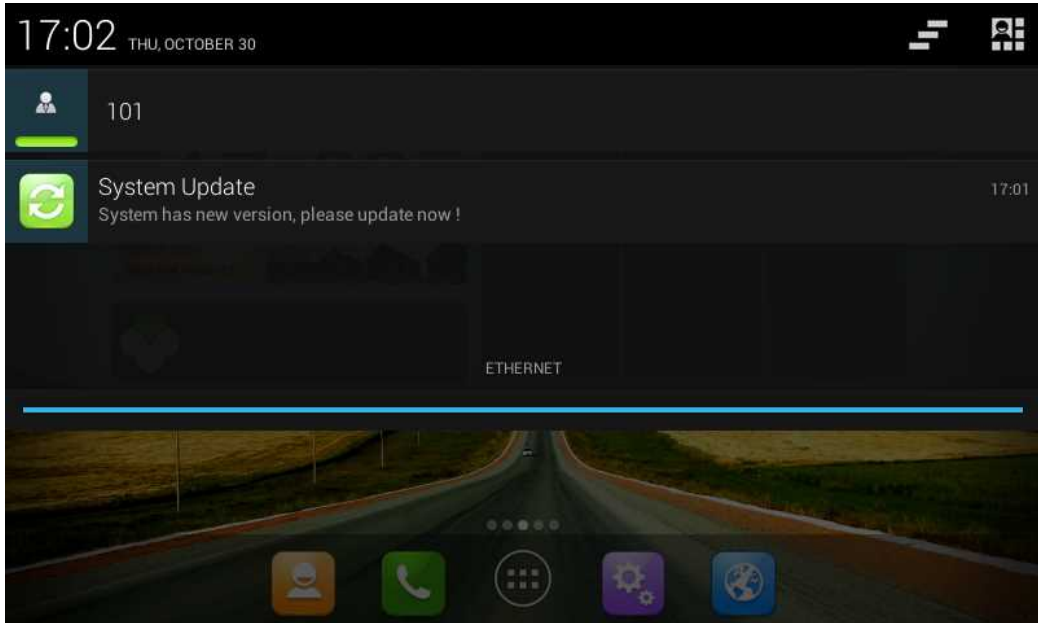

7 System Maintenance

7.1 System State Inspection

Mode 1: In the main screen, press "Menu" key on the hard keyboard-> System Settings-> About Multimedia Terminal

Mode 2: In the main screen, click  ->  -> About Multimedia Terminal
It will display phone status, software version and hardware version in this item.

7.2 IP Query

Mode 1: In the main screen, press "Menu" key on the hard keyboard-> System Settings-> Ethernet

Mode 2: In the main screen, click  ->  -> Ethernet

Mode 3: Press Speaker button or pick up to enter the dialing interface, click  on upper right corner -> enter the setting interface, check Status Info;

Mode 4: Slide down the top-left , click the account, enter the setting interface, check Status Info;

Mode 1 and Mode 2 can check IP address, subnet mask, gateway, DNS server etc. in Ethernet.

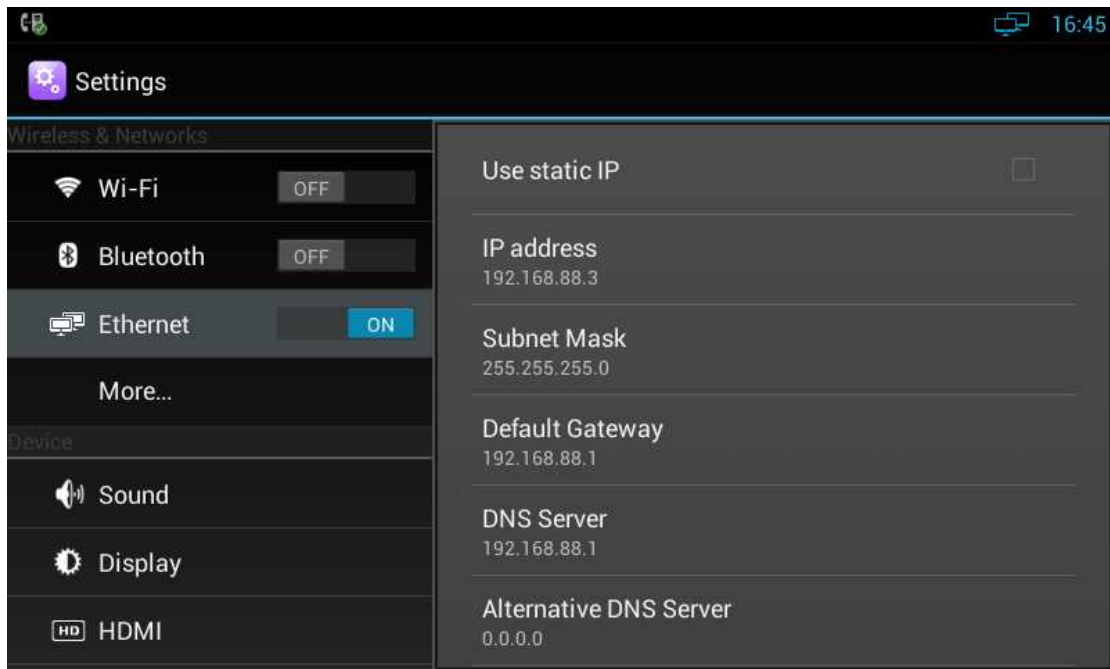

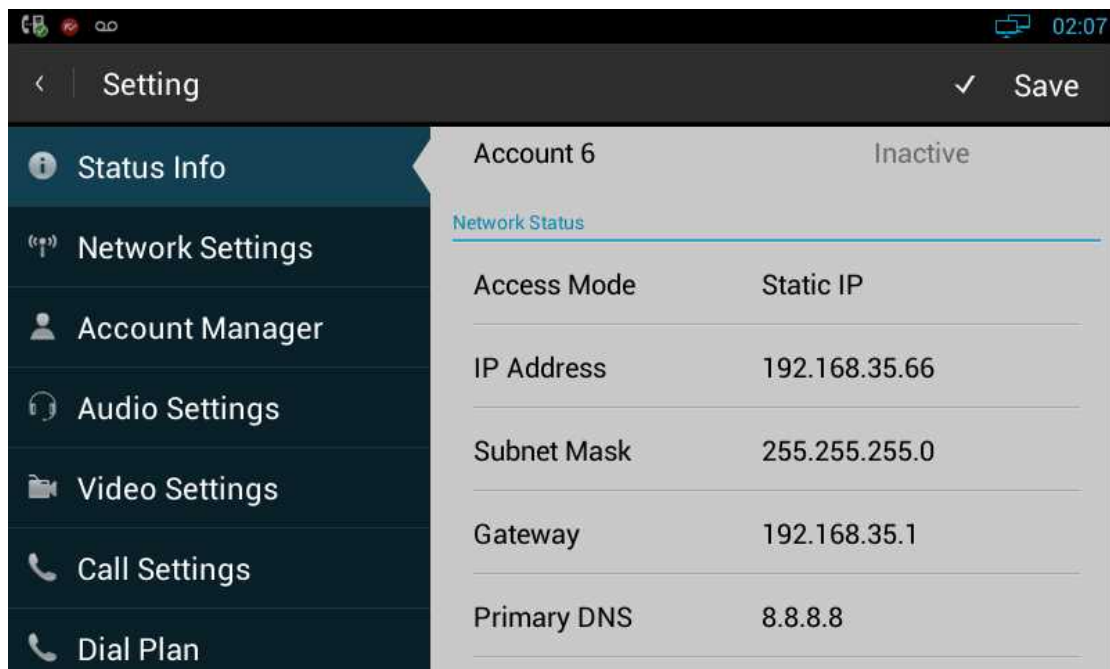

Mode 3 and Mode 4 can check the corresponding network information in setting interface.



7.3 SIP Account Registration Query

You can choose one of the following methods to enter the SIP account registration query. If the account is successfully registered, the icon will be light up in notification area of phone.

Mode 1: Press Speaker button or pick up to enter the dialing interface, click  on upper right corner, check Account Manager.

Mode 2: Slide down the top-left , click the account, enter the setup interface, check Account Manager.

7.4 Backup & Reset

Mode 1: In the main screen, press "Menu" key on the hard keyboard-> System Settings-> Backup & reset

Mode 2: In the main screen, click  ->  -> Backup & reset

Click "Factory data reset", click "Reset Multimedia Terminal", then the phone will restore to factory settings.

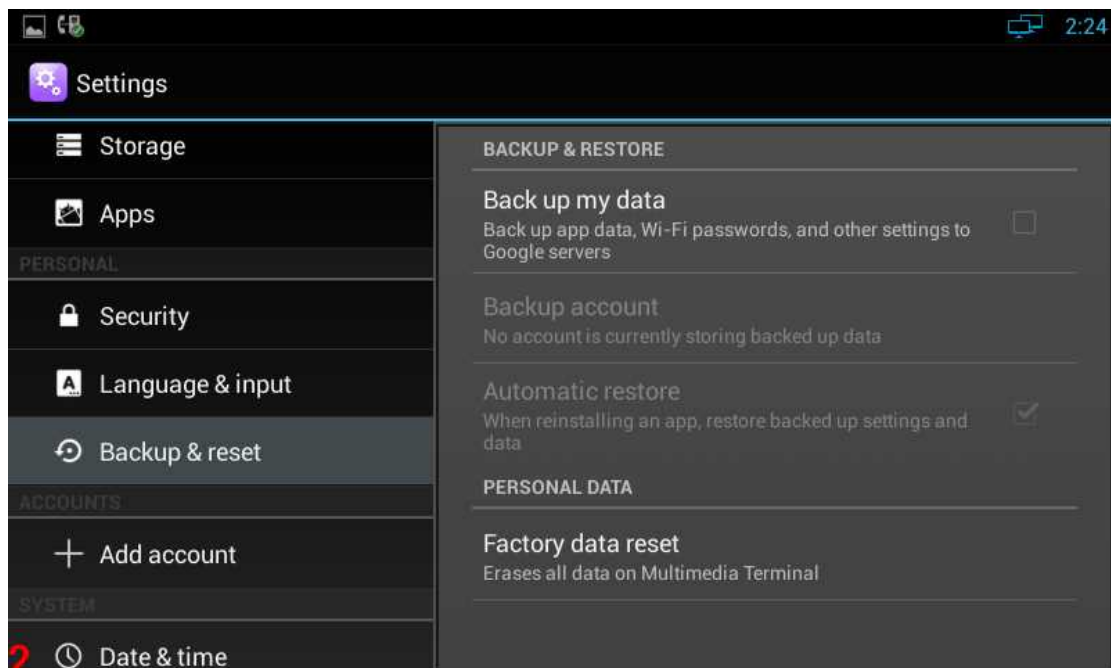

7.5 Failure Process



Failure 1: Power LED is off

- Please check whether the adapter fits this product requirement;
- Please check whether the outlet is working properly.

Failure 2: No voice when pick up the handset

- Please check whether the connection of handset is working properly;
- Please adjust the volume + key on keyboard when off-hook the phone, Observe the display of “volume” prompt. Please pay attention that the volume key in on-hook and off-hook situation is to adjust the ring volume and media volume (call volume) separately. These two adjustments are unrelated. Adjust the volume won’t change call volume when on-hook the phone.

Failure 3: Phone can’t dial properly

- Please check whether there is  at the top-right of screen. If not, please check whether the cable in LAN port is loose;
- Please check the IP address of phone via configuration (go to 4.2, “network configuration”);
- If it’s now in LAN, please check whether the IP address of phone is conflict with other devices in the same LAN.
- If the network connection is properly, please check whether the icon  of successful registration is in the notification area. If there is no explanation of configuration failure, please contact network administrator to recover it.

Failure 4: No ringing when incoming a call

- Please make sure the handset is completely hung on the base
- Please adjust the volume + key on keyboard when on-hook the phone, Observe the display of “volume” prompt. Please pay attention that the volume key in on-hook and off-hook situation is to adjust the ring volume and media volume (call volume) separately. These two adjustments are unrelated. Adjust the volume won’t change ring volume when off-hook the phone.

8 Web Interface

8.1 Web login

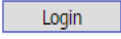
1. Open the browser on your computer.
2. Input the IP address in the address bar.
3. Enter the user name and password (user name: admin, password: admin), then click .

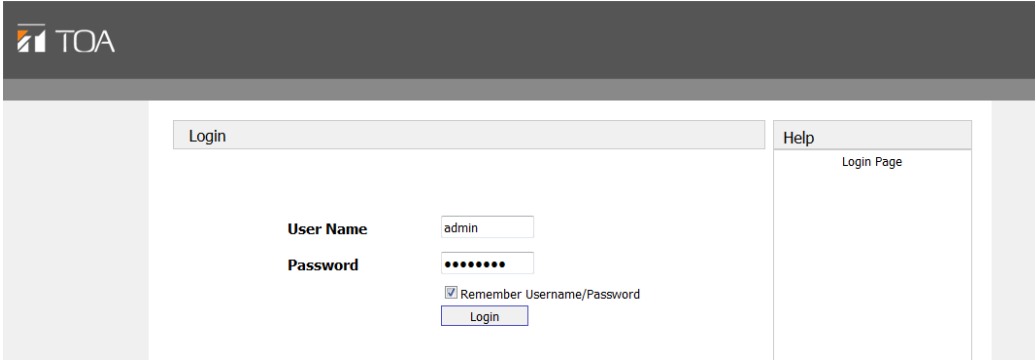

TOA

Login

Help

Login Page

User Name admin

Password

Remember Username/Password

Login

8.2 Status->Basic

Click Status->Basic to check the phone information.

The screenshot shows the TOA web interface with the following data:

Product Information	
Model	N-SF80MS1
Hardware Model	N-SF80MS1
MAC Address	C40938AD0C23
Firmware Version	47.192.7.551
Hardware Version	3.1

Network Information	
LAN Port Type	DHCP Auto
LAN Link Status	Connected
LAN IP Address	192.168.35.11
LAN Subnet Mask	255.255.255.0
LAN Gateway	192.168.35.1
LAN DNS1	192.168.35.1
LAN DNS2	

Account Information	
Account1	None@None Disabled
Account2	None@None Disabled
Account3	None@None Disabled
Account4	None@None Disabled
Account5	None@None Disabled
Account6	None@None Disabled

Sections	Description
Product Information	To display the device's information such as Model name, MAC address (IP device's physical address), Hardware Model, Firmware version and Hardware firmware.
Network Information	To display the device's Networking status(LAN Port),such as Port Type(which could be DHCP/Static/PPPoE), Link Status, IP Address, Subnet Mask, Gateway, Primary DNS server, Secondary DNS server.
Account Information	To display device's Account information and Registration status (account username, registered server's address, Register result).

8.3 Account->Basic

TOA LogOut

Account-Basic

SIP Account

Status	Disabled
Account	Account 1
Account Active	Disabled
Display Label	
Display Name	
Register Name	
User Name	
Password	*****

SIP Server 1

Server IP		Port	5060
Registration Period	1800		(30~65535s)

SIP Server 2

Server IP		Port	5060
Registration Period	1800		(30~65535s)

Outbound Proxy Server

Enable Outbound	Disabled		
Server IP		Port	5060
Backup Server IP		Port	5060

Transport Type

Transport Type	UDP
----------------	-----

NAT

NAT	Disabled		
Stun Server Address		Port	3478

Help

Note :
Max length of characters for input box:
255: Broadsoft Phonebook server address
127: Remote Phonebook URL & AUTOP Manual Update Server URL
63: The rest of input boxes

Warning :

Field Description :

Submit Shortcut

Sections	Description
SIP Account	<p>To display and configure the specific Account settings.</p> <ul style="list-style-type: none"> ● Status: To display register result. ● Display Label: Which is displayed on the phone's LCD screen. ● Display Name: Which is sent to the other call party for displaying. ● Register Name: Allocated by SIP server provider, used for authentication. ● User Name: Allocated by your SIP server provide, used for authentication. ● Password: Used for authorization.
SIP Server 1	<p>To display and configure Primary SIP server settings.</p> <ul style="list-style-type: none"> ● Server IP: SIP server address, it could be an URL or IP address. ● Registration Period: The registration will expire after Registration period, the SIP Multimedia Station will re-register automatically within registration period.
SIP Server 2	<p>To display and configure Secondary SIP server settings. This is for redundancy, if registering to Primary SIP server fails, the SIP Multimedia Station will go to Secondary SIP server for registering.</p> <p>Note: Secondary SIP server is used for redundancy, it can be left blank if there is not redundancy SIP server in user's environment.</p>
Outbound Proxy Server	<p>To display and configure Outbound Proxy server settings. An outbound proxy server is used to receive all initiating request messages and route them to the designated SIP server.</p> <p>Note: If configured, all SIP request messages from the SIP Multimedia Station will be sent to the outbound proxy server forcefully.</p>
Transport Type	<p>To display and configure Transport type for SIP message</p> <ul style="list-style-type: none"> ● UDP: UDP is an unreliable but very efficient transport layer protocol. ● TCP: Reliable but less-efficient transport layer protocol.
NAT	<p>To display and configure NAT(Net Address Translator) settings.</p> <ul style="list-style-type: none"> ● STUN: Short for Simple Traversal of UDP over NATS, a solution to solve NAT issues. <p>Note: By default, NAT is disabled.</p>

8.4 Account->Advanced

Account-Advanced

SIP Account

Account: Account 1

Audio Codes

Disabled Codes: []

Enabled Codes: G722, PCMU, PCMA, G729

Video Codes

Disabled Codes: []

Enabled Codes: H264, H263

Video Codec

Codec Name	H263	H264
Codec Resolution	CIF	CIF
Codec Bitrate	320	320
Codec Payload	34	104

Subscribe

MWI Subscribe: Disabled

MWI Subscribe Period: 1800 (120~65535s)

Voice Mail Number: []

BLF Expire: 1800 (120~65535s)

ACD Expire: 1800 (120~65535s)

DTMF

Type: RFC2833

How To Notify DTMF: Disabled

DTMF Payload: 101 (96~127)

Help

Note :
Max length of characters for input box:
255: Broadsoft Phonebook server address
127: Remote Phonebook URL & AUTOP Manual Update Server URL
63: The rest of input boxes

Warning :

Field Description :

Submit Shortcut
Submit Cancel

Sections	Description
SIP Account	To display current Account settings or to select which account to display.
Audio Codecs	To display and configure available/unavailable Audio codecs list. Codec means coder-decoder which is used to transfer analog signal to digital signal or vice versa. Familiar codecs are PCMU(G711U), PCMA(G711A), G722 (wide-band-width codecs),G729 and so on.
Video Codecs	To display and configure available/unavailable Video codecs list.

	<p>Video codec is used to transfer analog signal to digital. We can support 2 video codec - H263,H264</p> <ul style="list-style-type: none"> ● Codec Resolution: It can support QCIF, CIF, VGA, 4CIF, 720P. ● Codec Bitrate: The lowest bitrate is 128, the highest bitrate is 2048. ● Codec payload: From 90-119.
Subscribe	<p>To display or configure session timer settings.</p> <ul style="list-style-type: none"> ● Active: To enable or disable this feature, If enable, the ongoing call will be disconnected automatically once the session expired unless it's been refreshed by UAC or UAS. ● Session Expire: Configure session expire time. ● Session Refresher: To configure who should be response for refreshing a session. <p>Note: UAC means User Agent Client, here stands for SIP Multimedia Station. UAS means User Agent Server, here stands for SIP server.</p>
DTMF	<p>To display and configure DTMF settings.</p> <ul style="list-style-type: none"> ● Type: Support Inband,Info,RFC2833 or their combination. ● How To Notify DTMF: Only available when DTMF Type is Info/Info+Inband/Info+RFC2833. ● DTMF Payload: To configure payload type for DTMF. <p>Note: By default, DTMF type is RFC2833 which is the standard. Type Inband uses inband frequency to indicate DTMF tone which is most used to be compatible to traditional telephone server. Type Info use SIP Info message to indicate DTMF message.</p>

Call

Max Local SIP Port	<input type="text" value="5062"/>	(1024~65535)
Min Local SIP Port	<input type="text" value="5062"/>	(1024~65535)
Caller ID Header	<input type="text" value="FROM"/>	
Auto Answer	<input type="text" value="Disabled"/>	
Provisional Response ACK	<input type="text" value="Disabled"/>	
Register with user=phone	<input type="text" value="Disabled"/>	
Invite with user=phone	<input type="text" value="Disabled"/>	
PTime	<input type="text" value="20"/>	
Anonymous Call	<input type="text" value="Disabled"/>	
Anonymous Call Rejection	<input type="text" value="Disabled"/>	
Is escape non Ascii character	<input type="text" value="Enabled"/>	
Missed Call Log	<input type="text" value="Enabled"/>	
Prevent SIP Hacking	<input type="text" value="Disabled"/>	

Session Timer

Active	<input type="text" value="Disabled"/>	
Session Expire	<input type="text" value="1800"/>	(90~7200s)
Session Refresher	<input type="text" value="UAC"/>	

BLFList

BLFList URI	<input type="text"/>
BLFList PickUp Code	<input type="text"/>
BLFList BargeIn Code	<input type="text"/>

Broadsoft

AOC	<input type="text" value="Disabled"/>
-----	---------------------------------------

Note :

Max length of characters for input box:
 255: Broadsoft Phonebook server address
 127: Remote Phonebook URL & AUTOP Manual Update Server URL
 63: The rest of input boxes

Warning :

Field Description :

Submit Shortcut

Sections	Description
Call	<p>To display and configure call-related features.</p> <ul style="list-style-type: none"> ● Max Local SIP Port: To configure maximum local sip port for designated account. ● Min Local SIP Port: To configure minimum local sip port for designated account. ● Caller ID Header: To configure which Caller ID format to fetch for displaying on Phone UI. ● Auto Answer: If enabled, SIP Multimedia Station will be auto-answered when there is an incoming call for designated account. ● Provisional Response ACK: 100% reliability for all provisional message, this means it will send ACK every time the SIP Multimedia Station receive a provisional SIP message from SIP server. ● User=phone: If enabled, SIP Multimedia Station will send user=phone within SIP message. ● Anonymous Call: If enabled, all outgoing call for the designated account will be anonymous number. ● Anonymous Call Rejection: If enabled, all incoming anonym-out call for the designated account will be rejected. ● Missed Call Log: To display the miss call log.

	<ul style="list-style-type: none"> ● Prevent SIP Hacking: Enable to prevent SIP from hacking.
Session Timer	<p>To display or configure session timer settings.</p> <ul style="list-style-type: none"> ● Active: To enable or disable this feature, If enable, the ongoing call will be disconnected automatically once the session expired unless it's been refreshed by UAC or UAS. ● Session Expire: Configure session expire time. ● Session Refresher: To configure who should be response for refreshing a session. <p>Note: UAC means User Agent Client, here stands for SIP Multimedia Station. UAS means User Agent Server, here stands for SIP server.</p>
BLF List	<p>To display or configure BLF List URI address.</p> <ul style="list-style-type: none"> ● BLF List URI: BLF List is short for Busy Lamp Field List. ● BLFList PickUp Code: To set the BLF pick up code. <p>BLFList Bargeln Code: To set the BLF barge in code.</p>
Broadsoft	<p>To display or configure Broadsoft AOC feature.</p> <ul style="list-style-type: none"> ● AOC: A feature used to be accounting on Broadsoft platform. <p>Note: Please consult your administrator further information.</p>

Encryption

Voice Encryption(SRTP) Disabled ▾

NAT

UDP Keep Alive Messages Enabled ▾

UDP Alive Msg Interval 30 (5~60s)

RPort Disabled ▾

Conference

Type Local ▾

Conference URI

User Agent

User Agent

Remote User Agent

Separator

NumberList DoorPhone

Note :
Max length of characters for input box:
255: Broadsoft Phonebook server address
127: Remote Phonebook URL & AUTOP Manual Update Server URL
63: The rest of input boxes

Warning :

Field Description :

Submit Shortcut

Sections	Description
Encryption	Audio streaming can be encrypted by SRTP
NAT	<p>To display NAT-related settings.</p> <ul style="list-style-type: none"> ● UDP Keep Alive message: If enabled, SIP Multimedia Station will send UDP keep-alive message periodically to router to keep NAT port alive. ● UDP Alive Msg Interval: Keepalive message interval. ● Rport: Remote Port, if enabled, it will add Remote Port into outgoing SIP message for designated account.
Conference	<p>To select Local or network conference.</p> <ul style="list-style-type: none"> ● Type: To select desired conference type ● Conference URI: If network conference is selected, a network conference URI is needed to be input.
User Agent	One can customize User Agent field in the SIP message; If user agent is set to specific value, user could see the information from PCAP. If user agent is not set by default, user could see the company name, model number and firmware version from PCAP
Remote User Agent	<p>This feature need to be used with Auto Answer Door Station Delay. Go to the path: Phone->Call Feature.</p> <ul style="list-style-type: none"> ● Separator: Setup a separator, ,such as “,” , “*”or “#” to separate many Door Station account. ● NumberList Door Station: Fill multiple Door Station number .

8.5 Network->Basic

Sections	Description
LAN Port	<p>To display and configure LAN Port settings.</p> <ul style="list-style-type: none"> ● DHCP: If selected, IP phone will get IP address, Subnet Mask, Default Gateway and DNS server address from DHCP server automatically. ● Static IP: If selected, you have to set IP address, Subnet Mask, Default Gateway and DNS server manually.

8.6 Network ->Advanced

The screenshot displays the TOA Network-Advanced configuration interface. On the left, a navigation menu includes Status, Account, Network (with Advanced selected), Phone, PhoneBook, Upgrade, and Security. The main content area is titled 'Network-Advanced' and is divided into two sections: 'Local RTP' and 'VLAN'.
Local RTP Section:
 - Max RTP Port: 12000 (range 1024~65535)
 - Starting RTP Port: 11800 (range 1024~65535)
VLAN Section:
 - LAN Port: Active (Disabled), VID (1), Priority (0)
 - PC Port: Active (Disabled), VID (1), Priority (0)
 At the bottom of the main area are 'Submit' and 'Cancel' buttons. On the right, a 'Help' section contains a 'Note' about character limits, a 'Warning' section, and a 'Field Description' section with 'Submit Shortcut' buttons for 'Submit' and 'Cancel'.

Sections	Description
Local RTP	<p>To display and configure Local RTP settings.</p> <ul style="list-style-type: none"> ● Max RTP Port: Determine the maximum port that RTP stream can use. ● Min RTP Port: Determine the minimum port that RTP stream can use.
VLAN	<p>To display and configure VLAN settings.</p> <ul style="list-style-type: none"> ● LAN Port/PC Port: You can configure VLAN setting for both ports respectively. ● Active: To enable or disable VLAN feature for designated port. ● VID: To configure VLAN id for designated port. ● Priority: To select VLAN priority for designated port. <p>Note: Please consult your administrator for specific VLAN settings in your networking environment.</p>

8.7 Phone->Time/Lang

The screenshot shows the TOA web interface. The sidebar on the left includes sections for Status, Account, Network, Phone (with sub-items like Time/Lang, Preference, Call Feature, Audio, Video, Ext Key, Tones, Dial Plan, Action URL, Multicast), PhoneBook, Upgrade, and Security. The main content area is titled 'Time/Lang' and features a 'Web Language' section. This section has a 'Type' input field and a dropdown menu currently set to 'English'. Below these are 'Submit' and 'Cancel' buttons. To the right, a 'Help' sidebar provides additional information: a 'Note' regarding character limits for input boxes (255 for Broadsoft, 127 for Remote, 63 for others), a 'Warning' section, and a 'Submit Shortcut' with 'Submit' and 'Cancel' buttons.

Sections	Description
Web Language	To choose the web language.

8.8 Phone->Preference

The screenshot shows the TOA web interface. The top left has the TOA logo. The top right has a 'LogOut' link. A sidebar menu on the left lists various settings: Status, Account, Network, Phone (expanded), Time/Lang, Preference (highlighted), Call Feature, Audio, Video, Ext. Key, Tones, Dial Plan, Action URL, Multicast, PhoneBook, Upgrade, and Security. The main content area is titled 'Preference' and contains two sections: 'Key Press Sound' and 'Ringtone Volume'. Each section has a 'Volume' input field with the value '8' and a range '(0~15)'. Below these sections are 'Submit' and 'Cancel' buttons. On the right, there is a 'Help' section with a 'Note' (regarding character limits and server addresses), a 'Warning', and a 'Field Description' section with 'Submit Shortcut' buttons.

Sections	Description
Key Press Sound	To configure the sound volume for key press. <ul style="list-style-type: none"> ● Volume: The valid volume range is from 0~15, by default it's 8.
Ringtone Volume	To configure the sound volume for ringtone. <ul style="list-style-type: none"> ● Volume: The valid volume range is from 0~15, by default it's 8.

8.9 Phone ->Call Feature

The screenshot displays the TOA web interface for configuring call features. The main content area is titled 'Phone-Call Feature' and is organized into five distinct sections:

- Mode Phone:** Includes 'Feature Key Sync' (set to Disabled) and 'Mode' (selected as Phone, with Custom as an alternative).
- Forward Transfer:** Contains settings for 'Always Forward' (Disabled), 'Busy Forward' (Disabled), and 'No Answer Forward' (Disabled). Each setting includes a 'Target Number' input field and 'On Code'/'Off Code' fields.
- DND (Do Not Disturb):** Features 'DND Emergency' (Disabled), 'DND Priority' (Disabled), 'Return Code When DND' (set to 486(Busy Here)), and 'DND On Code'/'DND Off Code' input fields.
- Call Waiting:** Shows 'Call Waiting Enable' (Enabled) and 'Call Waiting Tone' (Enabled), along with 'On Code'/'Off Code' input fields.
- Auto Redial:** Includes 'Auto Redial' (Disabled), 'Auto Redial Interval' (set to 10 seconds), and 'Auto Redial Times' (set to 3).

The right sidebar provides additional information: a 'Note' about character limits for input boxes, a 'Warning' section, and a 'Field Description' section. At the bottom of the sidebar are 'Submit' and 'Cancel' buttons.

Sections	Description
Mode Phone	To enable or disable feature key sync. <ul style="list-style-type: none"> ● Feature Key Sync: To enable or disable feature key sync. ● Mode: Select the desired mode.
Forward Transfer	To display and configure Forward setting. Note: There are three types of forward: Always Forward,

	<p>Busy Forward and No answer Forward.</p> <ul style="list-style-type: none"> ● Always Forward: Any incoming call will be forwarded in any situation. ● Busy Forward: Any incoming call will be forwarded if SIP Multimedia Station is busy. ● No answer Forward: Any incoming call will be forwarded if it's no answer after a specific time.
Call Waiting	<p>To enable or disable Call Waiting.</p> <ul style="list-style-type: none"> ● Call Waiting Enable: If enabled, it allows SIP Multimedia Stations to receive a new incoming call when there is already an active call. ● Call Waiting Tone: If enabled, it allows SIP Multimedia Stations to play the call waiting tone to the waiting callee.
DND	<p>DND(Do Not Disturb) allows SIP Multimedia Stations to ignore any incoming calls.</p> <ul style="list-style-type: none"> ● Return Code when DND: Determine what response code should be sent back to server when there is an incoming call if DND on. ● DND On Code: The Code used to turn on DND on server's side, if configured, SIP Multimedia Station will send a SIP message to server to turn on DND on server side if you press DND when DND is off. ● DND Off Code: The Code used to turn off DND on server's side, if configured, SIP Multimedia Station will send a SIP message to server to turn off DND on server side if you press DND when DND is on.
Auto Redial	<p>Auto redial allows SIP Multimedia Stations to redial an unsuccessful call for designated times within designated interval.</p> <ul style="list-style-type: none"> ● Auto Redial: To enable or disable auto redial feature. ● Auto Redial Interval: Determine the interval between two consecutive attempts. ● Auto Redial Times: Determine how many times to redial.

Intercom

Active Enabled

Intercom Mute Disabled

HotLine

Active Disabled

Number

Delay Time 4 (0~5s)

ACD

ACD Activated Auto Disabled

ACD Activated Auto Timer 90 (0~180s)

Remote Control

Allowed Access IP List

Key As Send

Key As Send #

SIP Config

SIP Session T1 0.5 (0.5~10s)

SIP Session T2 4 (2~40s)

UACSTA

UACSTA Active Disabled

Register Name

Password *****

Server IP Port: 5060

Control Account Account 1

Door Phone

Auto Answer DoorPhone Delay 3 (3~30s)

Others

Return Code When Refuse 486(Busy Here)

Auto Answer Delay 0 (0~5s)

Answer Mode Audio

Early DTMF Disabled

Multicast Codec PCMU

Direct IP Enabled

Note :
Max length of characters for input box:
255: Broadsoft Phonebook server address
127: Remote Phonebook URL & AUTOP Manual Update Server URL
63: The rest of input boxes

Warning :

Field Description :

Submit Shortcut

Sections	Description
Intercom	<p>Intercom allow user to establish a call directly with the callee.</p> <ul style="list-style-type: none"> ● Active: To enable or disable Intercom feature. ● Intercom Mute: If enabled, once the call established, the callee will be muted.
Hot line	<p>HotLine allows user to call out a defined number automatically after hearing the dial-tone without dialing any number.</p> <ul style="list-style-type: none"> ● Active: To enable or disable HotLine feature. ● Number: To set a defined HotLine number.

	<ul style="list-style-type: none"> ● Delay Time: To set the automatically call out interval after hearing the dial-tone.
ACD	<p>ACD (Automatic Call Distribution) is most used in call-center market, it allows SIP Multimedia Station to login the system with multiple status so that the system could distribute an incoming calls to available user or agents.</p> <ul style="list-style-type: none"> ● ACD Activated Auto: If enabled, Agent status will turn to available automatically within a designated time(decided by ACD Activated Auto Timer). ● ACD Activated Auto Timer: To configure interval when will Agent status becomes available automatically. ● ACD Pwd Required: To enable the ACD password.
Remote Control	<p>Remote Control allows specific host to interact with SIP Multimedia Station by sending HTTP or HTTPS requests. The specific action could be answering an incoming call, hang-up an ongoing call and so on.</p> <ul style="list-style-type: none"> ● Allowed Access IP List: To configure the allowed host address. ● Note: For now, SIP Multimedia Station can only support IP address, IP address list and IP address pattern as allowed hosts
Key As Send	<p>Key As Send allows you to disable send key or assign pound key as send key.</p>
SIP Config	<p>Setup the SIP protocol package interval. T2 is maximum. The interval should be larger the T1, but less than T2.</p>
UACSTA	<p>Using CSTA for SIP phone user agents. It can control some features of calling. UACSTA is used to send ECMA-323(CSTA XML) information during SIP calling. The default status is disabled.</p>
Door Phone	<p>when there is incoming call from Door Station, setup the delay auto answer time, N-SP80MS1 will auto answer the call after the timeout.</p> <p>Note: if you enable Auto Answer function, this feature will be not available.</p>
Others	<ul style="list-style-type: none"> ● Return Code When Refuse: Allows user to assign specific code as return code to SIP server when an incoming call is rejected. ● Auto Answer Delay: To configure delay time before an incoming call is automatically answered.

8.10 Phone->Audio

The screenshot shows the TOA web interface for the 'Audio' configuration page. The left sidebar contains a navigation menu with categories like Status, Account, Network, Phone, Video, and Security. The main content area is titled 'Audio' and contains four sections: 'Echo Canceller' with VAD (Disabled) and CNG (Enabled); 'Mic Volume' with Handset Volume (8); 'Automatic Generation Control' with Automatic Gain Control (Sending-side) (Disabled), Automatic Gain Control (Receiving-side) (Disabled), and Automatic Gain Control Target (3); and 'NetEQ' with Filter forgetting factor base (250). A 'Submit' and 'Cancel' button are at the bottom. A 'Help' sidebar on the right provides a note about character limits and a warning about field descriptions.

Sections	Description
<p>Echo Canceller</p>	<p>Echo Canceller: To remove acoustic echo from a voice communication in order to improve the voice quality.</p> <ul style="list-style-type: none"> ● VAD(Voice Activity Detection): Allow SIP Multimedia Station to detect the presence or absence of human speech during a call. When detecting period of “silence”, VAD replaces that silence efficiently with special packets that indicate silence is occurring. It can facilitate speech processing, and deactivate some processes during non-speech section of an audio session. It can avoid unnecessary coding or transmission of silence packets in VoIP applications, saving on computation and network bandwidth. ● CNG(Comfort Noise Generation): Allow SIP Multimedia Station to generate comfortable background noise for voice communications during periods of silence in a conversation. It is a part of the silence suppression or VAD handling for VoIP technology. CNG, in conjunction

	with VAD algorithms, quickly responds when periods of silence occur and inserts artificial noise until voice activity resumes. The insertion of artificial noise gives the illusion of a constant transmission stream, so that background sound is consistent throughout the call and the listener does not think the line has released.
Mic Volume	To configure Microphone volume for handset mode.
Automatic Control Generation	N-SP80MS1 will auto adjust amplification circuit gain via signal. <ul style="list-style-type: none"> ● Automatic Gain Control(Sending-side): Disabled by default ● Automatic Gain Control(Receiving-side): Disabled by default ● Automatic Gain Control Target: Range from 1 to 20dB. 3dB by default.
NetEQ	Filter forgetting factor base: Range from 0~255. 250 by default.

8.11 Phone->Video

The screenshot displays the TOA web interface for configuring video settings. The left sidebar shows a navigation menu with categories like Status, Account, Network, Phone, and PhoneBook. The main content area is titled 'Video' and is divided into three sections: 'Media Feedback', 'H264 Settings', and 'Others'. Each section contains several configuration options, mostly using dropdown menus. The 'Media Feedback' section includes 'NACK' (set to 'Enabled') and 'Tmmb' (set to 'Disabled'). The 'H264 Settings' section includes 'H264 Profile' (set to 'Base Profile'), 'H264 Level' (set to '3.0'), 'IDR Interval' (set to '10'), and 'Rate Control' (set to 'crf'). The 'Others' section includes 'Hardware Endec Acceleration' (set to 'Disabled'), 'Hardware Decodec Acceleration' (set to 'Disabled'), 'Color Enhancement' (set to 'Enabled'), 'Image Quality' (set to 'High'), and 'Camera Priority' (set to 'Internal'). At the bottom of the main content area, there are 'Submit' and 'Cancel' buttons. On the right side, there is a 'Help' sidebar containing a 'Note' about character limits, a 'Warning' about field descriptions, and a 'Submit Shortcut' with 'Submit' and 'Cancel' buttons.

Sections	Description
Media Feedback	<ul style="list-style-type: none"> ● NACK: Enabled by default. ● Tmmbr: Send the maximum temporary rate request. Disabled by default.
H264 Settings	<p>H264: A video stream compression standard. Different from H263, it provides an approximately identical level of video stream quality but a half bit rate. This type of compression is sometimes called MPEG-4 part 10.</p> <p>To setup corresponding H264 video parameters.</p> <ul style="list-style-type: none"> ● H264 Profile: There are 4 modes-Base、 Main、 High、 Extend profile. Different profiles makes different coding function and video quality. ● H264 Level: Different profiles have corresponding Level value. ● IDR Interval:IDR means Instantaneous Decoding Refresh. It is used to control the process of coding and decoding. ● Rate Control: Choose one H264 video rate.
Others	<ul style="list-style-type: none"> ● Hardware Endec Acceleration: User can enable the Hardware Endec Acceleration when you need. ● Hardware Decodec Acceleration: Disabled by default. ● Color Enhancement: To increase the phone display color. Enabled by default. ● Image Quality: User can select Low, Middle or High mode.

8.12 Phone->Ext Key

Ext Key

Current Page: 1

Key	Type	Label	Value	Account	Extension
Key 1	N/A			Account	
Key 2	N/A			Account	
Key 3	N/A			Account	
Key 4	N/A			Account	
Key 5	N/A			Account	
Key 6	N/A			Account	
Key 7	N/A			Account	
Key 8	N/A			Account	
Key 9	N/A			Account	
Key 10	N/A			Account	
Key 11	N/A			Account	
Key 12	N/A			Account	
Key 13	N/A			Account	
Key 14	N/A			Account	
Key 15	N/A			Account	
Key 16	N/A			Account	
Key 17	N/A			Account	
Key 18	N/A			Account	
Key 19	N/A			Account	
Key 20	N/A			Account	

Help

Note :
Max length of characters for input box:
255: Broadsoft Phonebook server address
127: Remote Phonebook URL & AUTOP Manual Update Server URL
63: The rest of input boxes

Warning :

Field Description :

Submit Shortcut

Sections	Description
Current Page	N-SP80MS1 can support 4 pages Ext Key. 20 Ext Keys for each page.
Key	Allows user to assign specific feature to the designated key on expansion module. For keys, the available feature list: DND, Menu, MSG, Status, Book, Fwd, Pickup, Group Pickup, Intercom, Speed Dial, History, Favorites, Redial, Account, ACD, BLF, BLFList, Call Return, Hot Desking, Record, XML Browser, DTMF.

8.13 Phone->Dial Plan (Replace Rule)

The screenshot shows the TOA web interface for configuring Dial Plans. The main section is titled 'Dial Plan' and contains a 'Rules' table. The table has columns for Index (1-10), Account, Prefix, Replace, and a checkbox. Below the table are 'Add', 'Edit', and 'Delete' buttons. There is also an 'Area Code' section with input fields for Code, Min Length (1), Max Length (1), and Account (Auto). The 'Help' section on the right contains a note about character limits and a warning about field descriptions.

Sections	Description
Rules	Allow user to select Replace rule or Dial-now to display or edit.
Rules Modify	Allow user to modify selected rules information, for replace rule, you can modify related accounts, prefix and replace.
Area Code	Area codes are also known as NPAs (Numbering Plan Areas). They usually indicate different geographical areas within one country. If entered numbers match the predefined area code rule, the SIP Multimedia Station will automatically prefix outgoing number with area code. Note: There is only one area code rule supported.

8.14 Phone->Dial Plan (Dial Now)

The screenshot shows the TOA web interface for configuring the Dial Plan (Dial Now). The interface is divided into several sections:

- Rules:** A table with 10 rows, each representing a rule. The columns are Index, Account, and Dial Now Rule. There are checkboxes for each rule.
- Dial Now Delay:** A section with two fields: 'All Dial Delay' (set to Disabled) and 'Dial Now Delay' (set to 1).
- Area Code:** A section with four fields: 'Code' (empty), 'Min Length' (1), 'Max Length' (1), and 'Account' (Auto).
- Help:** A sidebar on the right containing a 'Note' (Max length of characters for input box: 255; Broadsoft Phonebook server address; 127; Remote Phonebook URL & AUTOP Manual Update Server URL; 63: The rest of input boxes), a 'Warning', and a 'Field Description'.

Sections	Description
Rules	Allow user to select Replace rule or Dial-now to display or edit.
Dial Now Delay	Allow user configure dial now delay time for dial now. It means user can configure the SIP Multimedia Station to dial out the phone number automatically after the designated delay time if it match any dial now rule.
Rules Modify	Allow user to modify selected rules information, for dial-now rule, user can modify related accounts, Dial now Rule itself.
Area Code	Area codes are also known as NPAs(Numbering Plan Areas). They usually indicate different geographical areas within one country. If entered numbers match the predefined area code rule, the SIP Multimedia Station will automatically prefix outgoing number with area code. Note: There is only one area code rule supported.

8.15 Phone->Action URL

TOA LogOut

Navigation: Status, Account, Network, **Phone**, Time/Lang, Preference, Call Feature, Audio, Video, Ext Key, Tones, Dial Plan, **Action URL**, Multicast, PhoneBook, Upgrade, Security

Action URL

ActionURL

Active	Disabled
Setup Completed	
Registered	
Unregistered	
Registered Failed	
Off Hook	
On Hook	
Incoming Call	
Outgoing Call	
Established	
Terminated	
Open DND	
Close DND	
Open Always FWD	
Close Always FWD	
Open Busy FWD	
Close Busy FWD	
Open No Answered FWD	
Close No Answered FWD	
Transfer Call	
Blind Transfer	
Attended Transfer	
Hold	
UnHold	
Mute	
UnMute	
MissedCall	
IP Changed	
FWD Incoming Call	
Reject Incoming Call	
Answer New Call	
Transfer Finished	
Transfer Failed	
Idle To Busy	
Busy To Idle	

Submit Cancel

Help

Note :
 Max length of characters for input box:
 255: Broadsoft Phonebook server address
 127: Remote Phonebook URL & AUTOP Manual Update Server URL
 63: The rest of input boxes

Warning :

Field Description :

Submit Shortcut
 Submit Cancel

Sections	Description
Action URL	To display and configure Action URL settings. Setup Completed: When the SIP Multimedia Station completes startup. <ul style="list-style-type: none"> ● Registered: When the SIP Multimedia Station successfully registers an account. ● Unregistered: When the SIP Multimedia Station logs off

	<p>the registered account.</p> <ul style="list-style-type: none"> ● Register Failed: When the SIP Multimedia Station fails to register an account. ● Off Hook: When the SIP Multimedia Station is off hook. ● On Hook: When the SIP Multimedia Station is on hook. ● Incoming Call: When the SIP Multimedia Station receives an incoming call. ● Outgoing Call: When the SIP Multimedia Station places a call. ● Established: When the SIP Multimedia Station establishes a call. ● Terminated: When the SIP Multimedia Station terminates a call. ● Open DND: When the SIP Multimedia Station enables the DND mode. ● Close DND: When the SIP Multimedia Station disables the DND mode. ● Open Always Forward: When the SIP Multimedia Station enables the always forward. ● Close Always Forward: When the SIP Multimedia Station disables the always forward. ● Open Busy Forward: When the SIP Multimedia Station enables the busy forward. ● Close Busy Forward: When the SIP Multimedia Station disables the busy forward. ● Open No Answer Forward: When the SIP Multimedia Station enables the no answer forward. ● Close No Answer Forward: When the SIP Multimedia Station disables the no answer forward ● Transfer Call: When the SIP Multimedia Station transfers a call. ● Blind Transfer: When the SIP Multimedia Station blind transfers a call. ● Attended Transfer: When the SIP Multimedia Station performs the semi-attended/attended transfer. ● Hold: When the SIP Multimedia Station places a call on hold. ● UnHold: When the SIP Multimedia Station retrieves a hold call. ● Mute: When the SIP Multimedia Station mutes a call. ● UnMute: When the SIP Multimedia Station un-mutes a call. ● Missed Call: When the SIP Multimedia Station misses a call.
--	---

	<ul style="list-style-type: none"> ● IP Changed: When the IP address of the SIP Multimedia Station changes. ● FWD Incoming Call: When the SIP Multimedia Station forwards an incoming call. ● Reject Incoming Call: When the SIP Multimedia Station rejects an incoming call. ● Answer New Call: When the SIP Multimedia Station answers a new call. ● Transfer Finished: When the SIP Multimedia Station completes to transfer a call. ● Transfer Failed: When the SIP Multimedia Station fails to transfer a call. ● Idle To Busy: When the state of the SIP Multimedia Station changes from idle to busy. ● Busy To Idle: When the state of phone changes from busy to idle.
--	---

8.16 Phone->Multicast

Multicast

Multicast Setting

Paging Barge: Disabled

Paging Priority Active: Enabled

Priority List

IP Address	Listening Address	Label	Priority
1 IP Address			1
2 IP Address			2
3 IP Address			3
4 IP Address			4
5 IP Address			5
6 IP Address			6
7 IP Address			7
8 IP Address			8
9 IP Address			9
10 IP Address			10

Submit Cancel

Help

Note :
 Max length of characters for input box:
 255: Broadsoft Phonebook server address
 127: Remote Phonebook URL & AUTOP Manual Update Server URL
 63: The rest of input boxes

Warning :

Field Description :

Submit Shortcut
 Submit Cancel

Sections	Description
Multicast Setting	<p>To display and configure the Multicast setting.</p> <ul style="list-style-type: none"> ● Paging Barge: Setup the priority level. A call is in a higher priority than a paging below this level. ● Paging priority Active: Enable or disable a priority between a call and a paging
Priority List	<p>To setup the multicast parameters.</p> <ul style="list-style-type: none"> ● Listening Address: Enter the IP address you need to listen ● Label: Input the label for each listening address

8.17 PhoneBook->Local Book

Local Book

Contact: All Contacts

Search: [Input Field] Search Reset

Dial: [Input Field] Auto Dial Hand Up

Index	Name	Number 1	Number 2	Number 3	Group	
1						<input type="checkbox"/>
2						<input type="checkbox"/>
3						<input type="checkbox"/>
4						<input type="checkbox"/>
5						<input type="checkbox"/>
6						<input type="checkbox"/>
7						<input type="checkbox"/>
8						<input type="checkbox"/>
9						<input type="checkbox"/>
10						<input type="checkbox"/>

Page 1 Prev Next Move To All Contacts Delete Delete All

Contact Setting

Name: [Input Field]
 Number 1: [Input Field]
 Number 2: [Input Field]
 Number 3: [Input Field]
 Group: Default

Add Edit Cancel

Group

Index	Name	Description	
1			<input type="checkbox"/>
2			<input type="checkbox"/>
3			<input type="checkbox"/>
4			<input type="checkbox"/>
5			<input type="checkbox"/>

Delete Delete All

Group Setting

Name: [Input Field]

Add Edit Cancel

Import/Export

Contact: [Browse...]

Import Export Cancel (.XML)
 Import Export Cancel (.CSV)

Help

Note :
 Max length of characters for input box:
 255: Broadsoft Phonebook server address
 127: Remote Phonebook URL & AUTOP Manual Update Server URL
 63: The rest of input boxes

Warning :
Field Description :

Sections	Description
Contact	To display and select local contact type. <ul style="list-style-type: none"> ● All Contacts: To display or edit all local contacts. ● Favorites: To display or edit favorites contacts. ● Black List: To display black list contacts.

Search	To search designated contacts from local phonebook.
Dial	To dial out a call or hang-up an ongoing call from Web UI. Note: For this feature, you need to have the remote control privilege to control SIP Multimedia Station via Web UI. Please refer to section “Remote Control” in the Web UI->Phone->Call Feature page.
Group	To display or edit Group contacts.
Group Setting	To display or change Group name, related ringtone or description.
Import/Export	To import or export the contact or blacklist file.

8.18 PhoneBook->Remote Book

The screenshot displays the 'Remote Book' configuration interface. It features a table with the following structure:

Index	Local Book URL	Local Book Name
1		
2		
3		
4		
5		

Below the table, there are configuration fields: 'Search Remote Phonebook Name' is set to 'Enabled', and 'Refresh Interval' is set to '3600' (with a note '(120~2592000s)'). 'Submit' and 'Cancel' buttons are present at the bottom of the main form area.

The right-hand 'Help' section contains the following text:

Note :
Max length of characters for input box:
255: Broadsoft Phonebook server address
127: Remote Phonebook URL & AUTOP Manual
Update Server URL
63: The rest of input boxes

Warning :
Field Description :
Submit Shortcut
Submit Cancel

Sections	Description
Remote Book	To display and configure Remote Book settings. <ul style="list-style-type: none"> ● Index: To select desired Remote Book item to display and configure. ● Local Book URL: To configure remote book server address

	<ul style="list-style-type: none"> ● Local Book Name: To configure display remote book name on Phone UI ● Search Remote Phonebook Name: To enable or disable search remote phonebook name ● Search Flash Interval: To set interval (Range from 120s to 2592000s) <p>Note: SIP Multimedia Station supports at most 5 remote books. Please refer to your administrator for how to establish a remote book server and how to create remote book xml file.</p>
--	--

8.19 PhoneBook->Call Log

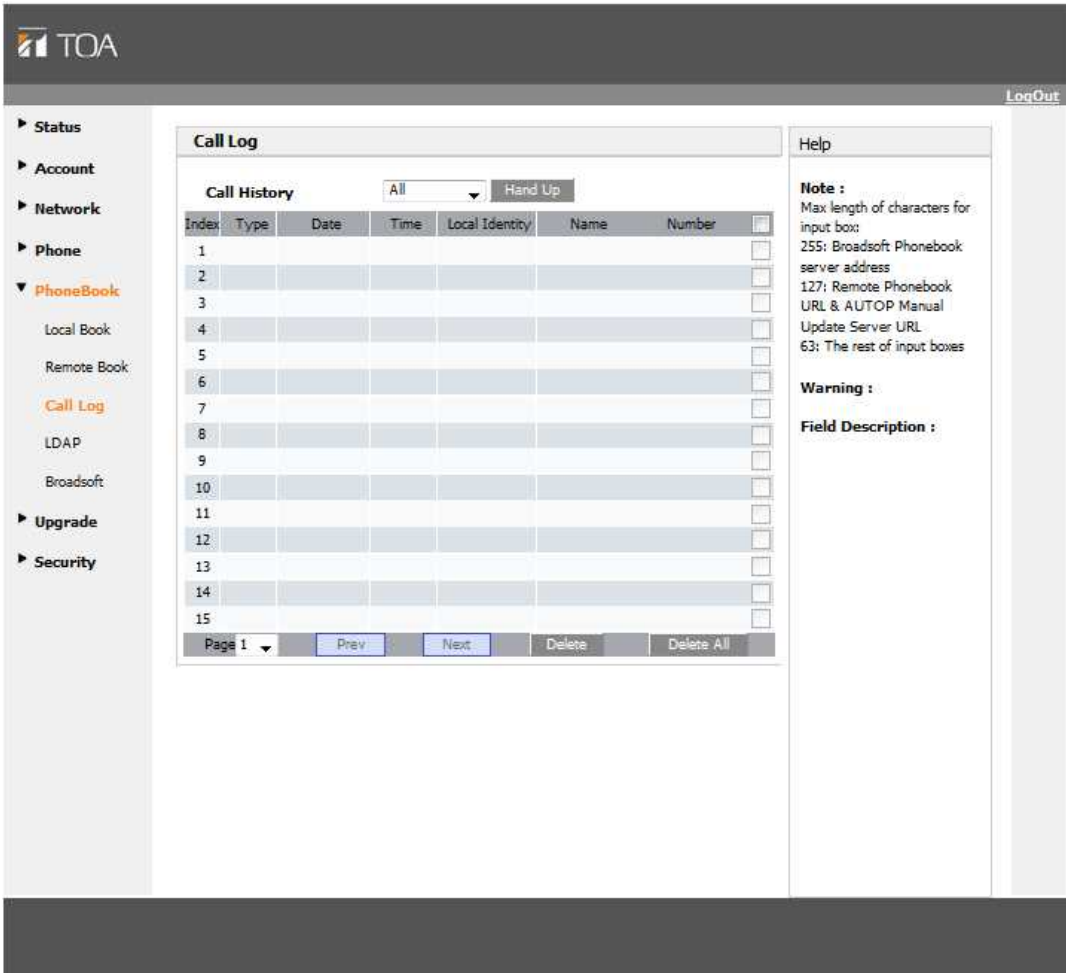

Sections	Description
Call History	To display call history records. Available call history types are All calls, Dialed calls, Received calls, Missed calls, Forwarded calls.

	<ul style="list-style-type: none"> ● HangUp: To click to hang-up ongoing call on the SIP Multimedia Station. <p>Note: For “HangUp” feature, you need to have the remote control privilege to control SIP Multimedia Station via Web UI. Please refer to section “Remote Control” in the Web UI->Phone->Call Feature page.</p>
--	---

8.20 PhoneBook->LDAP

Sections	Description
LDAP	<p>To display and configure LDAP phonebook settings.</p> <ul style="list-style-type: none"> ● Name Filter: The settings used to tell LDAP server what name attributes to search. ● Number Filter: The settings used to tell LDAP server what number attributes to search. ● Server: To configure LDAP server’s address. ● Port: To configure LDAP server’s port. ● Base DN: To configure searching base DN on LDAP

	<p>server.</p> <ul style="list-style-type: none"> ● User Name: To configure user name for accessing LDAP server. ● Password: To configure password for accessing LDAP server. ● Name Attribute: To configure which name attributes should be feedback from LDAP server. ● Number Attribute: To configure which number attributes should be feedback from LDAP server. ● Display Name: To configure display name on Phone UI when there is any searching result from LDAP server. ● Max Hits: To configure the maximum size of result response from LDAP server. ● Search Delay Time: To configure delay time before initiate LDAP searching request after you input a value from Phone UI. <p>Note: For setting details, please consult with your system administrator for further information.</p>
--	---

8.21 PhoneBook->Broadsoft

The screenshot displays the configuration page for Broadsoft PhoneBook. The left sidebar contains a navigation menu with the following items: Status, Account, Network, Phone, PhoneBook (expanded), Local Book, Remote Book, Call Log, LDAP, Broadsoft (highlighted), Upgrade, and Security. The main content area is titled 'Broadsoft' and features a 'Broadsoft PhoneBook' form with the following fields:

- PhoneBook Item: Item1
- Display Name: Group
- Server Address: [Empty text box]
- Server Port: (1~65535)
- User Name: [Empty text box]
- Password: [Masked text box]

Below the form are 'Submit' and 'Cancel' buttons. To the right of the form is a 'Help' section containing the following text:

Note :
Max length of characters for input box:
255: Broadsoft Phonebook server address
127: Remote Phonebook URL & AUTOP Manual Update Server URL
63: The rest of input boxes

Warning :

Field Description :

Submit Shortcut
Submit Cancel

Sections	Description
Broadsoft PhoneBook	<p>To display and configure Broadsoft PhoneBook settings.</p> <ul style="list-style-type: none"> ● PhoneBook Item: To select specific item to configure. ● Display Name: The name displayed at SIP Multimedia Station's LCD screen when accessed via Phone UI. ● Server Address: Broadsoft PhoneBook server's address. ● Server Port: Broadsoft PhoneBook server's port. ● User Name: Username used to access Broadsoft PhoneBook server. ● Password: Password used to access Broadsoft PhoneBook server. <p>Note: SIP Multimedia Station supports at most 5 Broadsoft PhoneBook items. For Broadsoft PhoneBook's server address, port, username and password, you need to consult your Broadsoft service provider for further information.</p>

8.22 Upgrade->Basic

The screenshot displays the TOA web interface for the 'Upgrade-Basic' section. The sidebar on the left lists various system settings, with 'Upgrade' expanded to show 'Basic' and 'Advanced' options. The main content area shows the current firmware and hardware versions, and provides options to upgrade the device, reset to factory settings, or reboot. A help section on the right provides additional information and warnings.

Sections	Description
Firmware version	To display firmware version, firmware version starts with MODEL name.
Hardware Version	To display Hardware version.
Upgrade	To select upgrading zip file from local or a remote server automatically. Note: Please make sure it's right file format for right model.
Reset to Factory Setting	To setup N-SP80MS1 to factory setting
Reset Config to Factory Setting	To setup the configuration file to factory setting.
Reboot	Click the submit to reboot the device

8.23 Upgrade->Advanced

- ▶ Status
- ▶ Account
- ▶ Network
- ▶ Phone
- ▶ PhoneBook
- ▼ Upgrade
 - Basic
 - Advanced
- ▶ Security

Upgrade-Advanced

PNP Option

PNP Config Enabled ▼

DHCP Option

Custom Option (128~254)
(DHCP Option 66/43 is Enabled by Default)

Manual Autop

URL

User Name

Password

Common AES Key

AES Key(MAC)

Automatic Autop

Mode Power On ▼

Schedule Sunday ▼

Hour(0~23)

Min(0~59)

Clear MDS

Export Autop Template

Reboot Schedule

Mode Disabled ▼

Schedule Every Day ▼

Hour(0~23)

System Log

LogLevel 3 ▼

Export Log

Remote System Log Disabled ▼

Remote System Server

PCAP

PCAP

PCAP Auto Refresh Disabled ▼

Others

Config File(.tgz/.conf/.cfg) ファイルが選択されていません。

Help

Note :
Max length of characters for input box:
255: Broadsoft Phonebook server address
127: Remote Phonebook URL & AUTOP Manual Update Server URL
63: The rest of input boxes

Warning :

Field Description :

Submit Shortcut

Sections	Description
PNP Option	To display and configure PNP setting for Auto Provisioning. <ul style="list-style-type: none"> ● PNP: Plug and Play, once PNP is enabled, the phone will

	<p>send SIP subscription message to PNP server automatically to get Auto Provisioning server's address. By default, this SIP message is sent to multicast address 224.0.1.75(PNP server address by standard).</p>
DHCP Option	<p>To display and configure custom DHCP option.</p> <ul style="list-style-type: none"> ● DHCP option: If configured, IP Phone will use designated DHCP option to get Auto Provisioning server's address via DHCP. <p>This setting require DHCP server to support corresponding option.</p>
Manual Update Server	<p>To display and configure manual update server's settings.</p> <ul style="list-style-type: none"> ● URL: Auto provisioning server address. ● User name: Configure if server needs an username to access, otherwise left blank. ● Password: Configure if server needs a password to access, otherwise left blank. ● Common AES Key: Used for SIP Multimedia Station to decipher common Auto Provisioning configuration file. ● AES Key (MAC): Used for SIP Multimedia Station to decipher MAC-oriented auto provisioning configuration file(for example, file name could be 0c1105888888.cfg if SIP Multimedia Station's MAC address is 0c1105888888). <p>Note: AES is one of many encryption, it should be configure only configure filed is ciphered with AES, otherwise left blank.</p>
Automatic AutoP	<p>To display and configure Auto Provisioning mode settings. This Auto Provisioning mode is actually self-explanatory. For example, mode "Power on" means SIP Multimedia Station will go to do Provisioning every time it powers on.</p>
Reboot Schedule	<p>Enable reboot schedule, and setup the concrete day and time, the phone will reboot according to the configuration.</p>
System Log	<p>To display syslog level and export syslog file.</p> <ul style="list-style-type: none"> ● Syslog level: From level 0~7.The higher level means the more specific syslog is saved to a temporary file. By default, it's level 3. ● Export Log: Click to export temporary syslog file to local PC.
PCAP	<p>To start, stop packets capturing or to export captured Packet file.</p> <ul style="list-style-type: none"> ● Start: To start capturing all the packets file sent or received from SIP Multimedia Station. ● Stop: To stop capturing packets. <p>Note: SIP Multimedia Station will save captured packets file to a temporary file, this file maximum size is 1M(mega bytes),</p>

	and will top capturing once reaching this maximum size.
Others	To display or configure others features from this page. <ul style="list-style-type: none"> ● Config file: To export or import configure file for SIP Multimedia Station.

8.24 Security->Basic

Sections	Description
Web Password Modify	To modify user's password. <ul style="list-style-type: none"> ● User Name: Choose the character you are.(admin or user) ● Current Password: The current password you used. ● New Password: Input new password you intend to use. ● Confirm Password: Repeat the new password. <p>Note: Security is configurable via web only.</p>
Session Time Out Value	Limit the login time. Exceed the configured time, user need to login the website again.

8.25 Security->Advanced

TOA LogOut

Advanced

Web Server Certificate

Index	Issue To	Issuer	Expire Time	Delete
1	IPphone	IPphone	Sun Oct 9 16:00:00 2034	Delete

Web Server Certificate Upload

Browse... Submit Cancel

Client Certificate

Index	Issue To	Issuer	Expire Time	
1				<input type="checkbox"/>
2				<input type="checkbox"/>
3				<input type="checkbox"/>
4				<input type="checkbox"/>
5				<input type="checkbox"/>
6				<input type="checkbox"/>
7				<input type="checkbox"/>
8				<input type="checkbox"/>
9				<input type="checkbox"/>
10				<input type="checkbox"/>

Delete Cancel

Client Certificate Upload

Index: Auto

Only Accept Trusted Certificates: Disabled

Help

Note :
Max length of characters for input box:
255: Broadsoft Phonebook server address
127: Remote Phonebook URL & AUTOP Manual Update Server URL
63: The rest of input boxes

Warning :
Field Description :

Sections	Description
Web Server Certificate	To display or delete Certificate which is used when SIP Multimedia Station is connected from any incoming HTTPs request. Note: The default certificate could not be deleted.
Web Server Certificate Upload	To upload a certificate file which will be used as server certificate.
Client Certificate	To display or delete Certificates which is used when SIP Multimedia Station is connecting to any HTTPs server.
Client Certificate Upload	To upload certificate files, this is used as client certificate. <ul style="list-style-type: none"> ● Only Accept trusted Certificates: If this option is enabled, only trusted certificates will be accepted.