

■ DESCRIPTION

The TS-773 is a designed microphone for exclusive use with the conference units of the TS-770 series Conference system.
 Ring type In-Use lamp located at the microphone head permits displaying the operation status of the conference units.

■ SPECIFICATIONS

Type	Electret condenser microphone
Directivity	Unidirectional
Rated Impedance	1.8 kΩ
Rated Sensitivity	-37 dB (1 kHz 0 dB = 1 V/Pa)
LED Indicator	Speech indicator (ring type)
Frequency Response	100 Hz - 13 kHz
Output Connector	Equivalent to XLR-4-12C
Finish	Gooseneck: Stainless steel, black Other: ABS resin, black
Weight	90 g (0.2 lb)
Applicable Unit (Option)	Chairman unit: TS-771 Delegate unit: TS-772

■ APPEARANCE

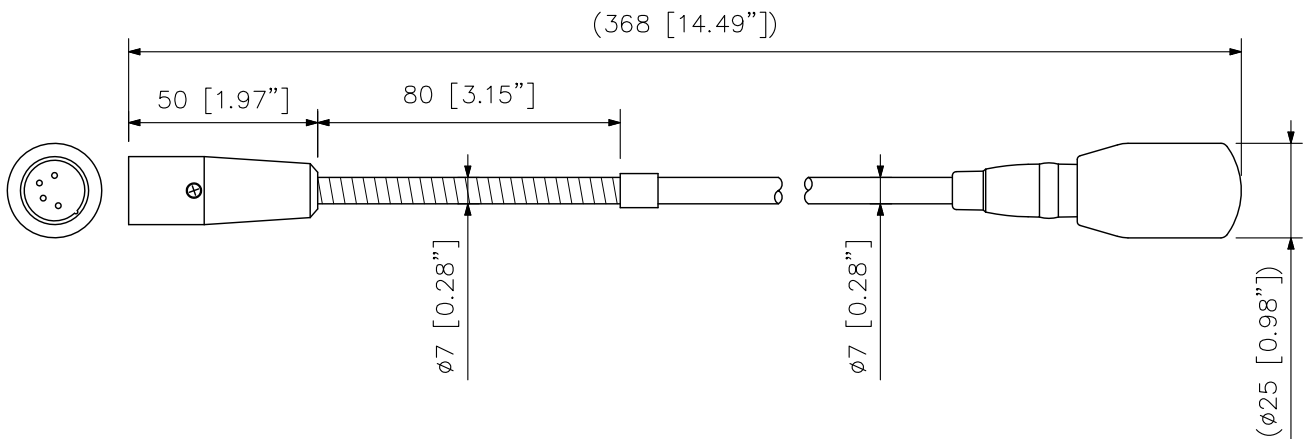

UNIT:mm SCALE:1/2

Note: Numerical values in parentheses are for reference only.