

PAGING HORN SPEAKER

● DESCRIPTION

The ZH-625S is designed to be used exclusively in the paging or intercom system. To avoid the unit's failure, do not sound a signal tone from this speaker for long time.

● SPECIFICATIONS

Model	ZH-625S	
Input	Rated 25W	
Impedance	8Ω	
Sound Pressure Level	≥ 110dB (1W, 1M) (at 500 ~ 2.5kHz peak level)	
Frequency response	Low : ≤ 297 High : ≥ 8,409	
Sensitivity as microphone (0dBm = 1mW / 10dyne / cm ²)	-20dBm at 1kHz	
Ambient Temperature	-20°C to +55°C	
Finish		
1	HORN-A	Aluminium (off white)
2,5	HORN-BC, REAR COVER	Weather proof as ABS resin (off white)
3	BRACKET HOLDER	Aluminium die cast (off white)
4	BRACKET	Steel (dark grey)
Weight	1.7kg	

● APPEARANCE

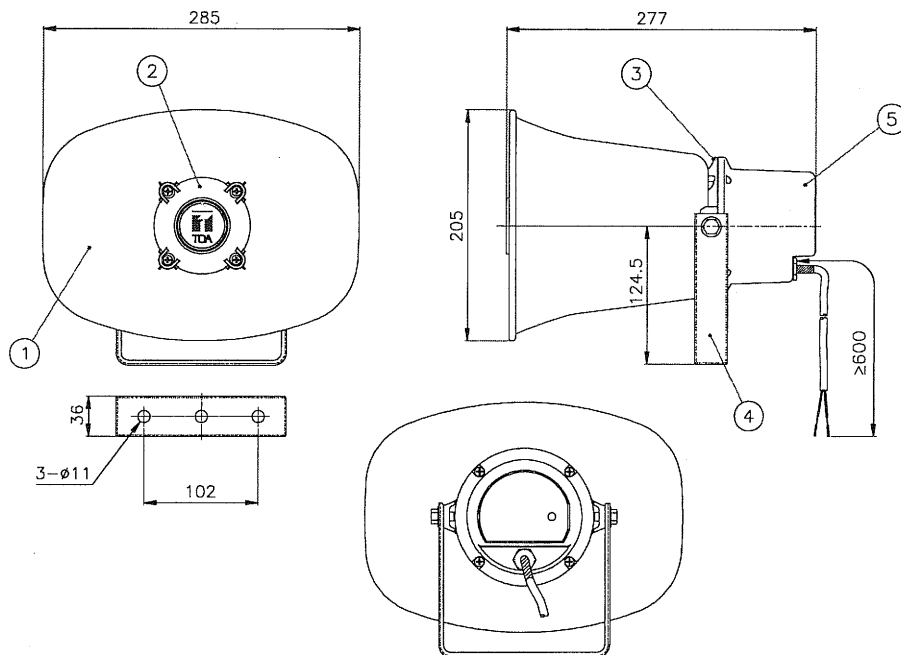

Connection diagram

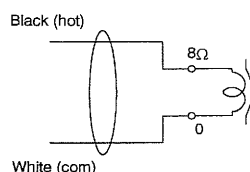

UNIT : MM